

U.S. CHEMICAL SAFETY AND HAZARD INVESTIGATION BOARD

# INVESTIGATION REPORT

## THERMAL DECOMPOSITION INCIDENT

(3 Killed)

**BPAMOCO POLYMERS, INC.**

AUGUSTA, GEORGIA

MARCH 13, 2001

### KEY ISSUES

RECOGNITION OF REACTIVE HAZARDS  
LEARNING FROM NEAR-MISS INCIDENTS  
OPENING OF PROCESS EQUIPMENT

REPORT No. 2001-03-I-GA

ISSUE DATE: JUNE 2002



This investigation report examines the thermal decomposition incident that occurred on March 13, 2001, at the BP Amoco Polymers, Inc., plant in Augusta, Georgia. Three workers were killed. This report identifies the root and contributing causes of the incident and makes recommendations for recognizing reactive hazards, learning from near-miss incidents, and opening process equipment.

The U.S. Chemical Safety and Hazard Investigation Board (CSB) is an independent Federal agency whose mission is to ensure the safety of workers and the public by preventing or minimizing the effects of chemical incidents. CSB is a scientific investigative organization; it is not an enforcement or regulatory body. Established by the Clean Air Act Amendments of 1990, CSB is responsible for determining the root and contributing causes of accidents, issuing safety recommendations, studying chemical safety issues, and evaluating the effectiveness of other government agencies involved in chemical safety. No part of the conclusions, findings, or recommendations of CSB relating to any chemical incident may be admitted as evidence or used in any action or suit for damages arising out of any matter mentioned in an investigation report (see 42 U.S.C. § 7412(r)(6)(G)). CSB makes public its actions and decisions through investigation reports, summary reports, safety bulletins, safety recommendations, special technical publications, and statistical reviews. More information about CSB may be found on the World Wide Web at <http://www.chemsafety.gov>.

---

**Salus Populi Est Lex Suprema**  
**People's Safety is the Highest Law**

---

**Information about available publications may be obtained by contacting:**

U.S. Chemical Safety and Hazard  
Investigation Board  
Office of Prevention, Outreach,  
and Policy  
2175 K Street NW, Suite 400  
Washington, DC 20037  
(202) 261-7600

**CSB publications may be purchased from:**

National Technical Information  
Service  
5285 Port Royal Road  
Springfield, VA 22161  
(800) 553-NTIS or  
(703) 487-4600

Email: [info@ntis.fedworld.gov](mailto:info@ntis.fedworld.gov)

For international orders, see:  
[http://www.ntis.gov/support/  
cooperat.htm](http://www.ntis.gov/support/cooperat.htm).

For this report, refer to NTIS  
number PB2002-107365.



EXECUTIVE SUMMARY .....	9
1.0 INTRODUCTION .....	19
1.1 Background .....	19
1.2 Investigative Process .....	19
1.3 BP Amoco Polymers Augusta Facility .....	19
1.4 History of Process Development .....	20
2.0 PROCESS DESCRIPTION .....	21
2.1 Chemistry .....	21
2.2 Process Configuration .....	22
2.3 Polymer Catch Tank and Reactor Knockout Pot .....	23
3.0 DESCRIPTION OF INCIDENT .....	27
3.1 Pre-Incident Events .....	27
3.1.1 Attempted Startup .....	27
3.1.2 Aborted Startup .....	28
3.1.3 Preparation for Removal of Polymer Catch Tank Cover .....	29
3.2 Incident Description .....	30
3.2.1 Cover Failure and Expulsion of Hot Plastic .....	30
3.2.2 Subsequent Fire .....	30
3.2.3 Emergency Response .....	31
3.3 Reconstructive Analysis .....	32
3.3.1 Extruder Failure .....	32
3.3.2 Polymer Catch Tank .....	32
3.3.3 Physical Testing and Chemistry .....	34
3.3.4 Vessel Pressurization .....	35
4.0 ANALYSIS OF INCIDENT .....	37
4.1 Reactive Chemical Hazard Management .....	37
4.2 Process Safety Information .....	39
4.3 Management of Change .....	41
4.4 Process Hazard Analysis .....	42
4.5 Design Deficiencies .....	44
4.6 Procedures for Safe Opening of Process Equipment .....	47
4.7 Incident and Near-Miss Investigations .....	48
4.7.1 Exploding Polymer Pods .....	48
4.7.2 Waste Polymer Fires .....	49
4.7.3 Inadequate Review of Cumulative Incidents .....	50
4.8 Review of Similar Incident .....	51

---

# Contents (cont'd)

---

5.0 REGULATORY ANALYSIS .....	53
5.1 Process Safety Management .....	53
5.2 Lockout/Tagout .....	55
6.0 ROOT AND CONTRIBUTING CAUSES .....	57
6.1 Root Causes .....	57
6.2 Contributing Causes .....	58
7.0 RECOMMENDATIONS .....	61
8.0 REFERENCES .....	65
APPENDIX A: RECONSTRUCTION OF INCIDENT .....	67
A.1 Post-Incident Scene .....	67
A.2 Extruder Failure .....	71
A.3 Polymer Catch Tank .....	72
A.4 Physical Testing and Chemistry.....	78
A.5 Vessel Pressurization .....	84
APPENDIX B: TIMELINE .....	85
APPENDIX C: LOGIC DIAGRAM .....	93

1	Highly Simplified Flow Diagram for Amodel Production .....	22
2	KD-502 Polymer Catch Tank (simplified representation) .....	24
3	KD-502 Polymer Catch Tank (actual vessel with one cover removed) .....	24
4	Simplified Process Diagram Showing Polymer Catch Tank and Reactor Knockout Pot .....	25
5	Damaged Girder .....	30
6	Polymer Catch Tank Cover .....	31
7	Polymer Plugging Polymer Catch Tank Vent Nozzle .....	33
A-1	Polymer Plugging Polymer Catch Tank Vent Nozzle .....	67
A-2	Failed Bolts From Polymer Catch Tank Cover .....	68
A-3	Reactor Knockout Pot With Internal Frame Visible .....	68
A-4	Vent Line Obstructed by Polymer Layers .....	69
A-5	Polymer Scattered Throughout Work Area .....	70
A-6	Material Extracted From Polymer Catch Tank on March 11, Prior to Incident .....	73
A-7	Normal Operation–Settlement of Particles .....	75
A-8	Polymer Catch Tank Filled Beyond Working Capacity– Particles Entrained in Vent Vapor .....	75
A-9	Sample of Material Expelled From Polymer Catch Tank .....	79
A-10	Layer of Hardened Polymer Taken From Inside Perimeter of Polymer Catch Tank .....	79
A-11	ARC Data for Amodel .....	82

---

# Acronyms and Abbreviations

---

AICHE	American Institute of Chemical Engineers
ARC	Accelerating rate calorimeter
ASTM	American Society for Testing and Materials
BP	British Petroleum
°C	Degrees Celsius
CCPS	Center for Chemical Process Safety
CFR	Code of Federal Regulations
CPR	Cardiopulmonary resuscitation
CSB	U.S. Chemical Safety and Hazard Investigation Board
FEA	Finite element analysis
HAZOP	Hazard and operability
HSE	Health and Safety Executive (United Kingdom)
IChemE	Institution of Chemical Engineers (United Kingdom)
lb/gal	Pounds per gallon
L.L.C.	Limited liability company
LTA	Less than adequate
MOC	Management of change
MSDS	Material safety data sheet
OSHA	Occupational Safety and Health Administration
PCR	Process change request
PHA	Process hazard analysis
psia	Pounds per square inch absolute
psig	Pounds per square inch gage
PSM	Process safety management
R&D	Research and development
SA	Société anonyme



---

# Executive Summary

---

## ES.1 Introduction

On March 13, 2001, three people were killed as they opened a process vessel containing hot plastic at the BP Amoco Polymers (now Solvay Advanced Polymers, L.L.C.) plant in Augusta, Georgia. They were unaware that the vessel was pressurized.

The workers were killed when the partially unbolted cover blew off the vessel, expelling hot plastic. The force of the release caused some nearby tubing to break. Hot fluid from the tubing ignited, resulting in a fire. Because of the serious nature of this incident, the U.S. Chemical Safety and Hazard Investigation Board (CSB) initiated an investigation to determine the root and contributing causes and to issue recommendations to help prevent similar occurrences.

---

## ES.2 Incident

The BP Amoco Polymers Augusta facility produced plastics, including Amodel, a hard but moldable high-performance nylon. Amodel is manufactured by passing a solution of di-amines and di-carboxylic acids through a series of reactors. The reaction is completed in an extruder,<sup>2</sup> and the material is then formed and cooled into solid pellets.

Workers were attempting to open a cover on a process vessel when the incident occurred. The vessel—referred to as the polymer catch tank (KD-502)—was designed to receive partially reacted waste Amodel diverted from a chemical reactor during periods of startup and shutdown.

Twelve hours prior to the incident, an attempt was made to start the production unit. After approximately 1 hour, the startup was aborted due to problems with the extruder downstream of the reactor—but not before an unusually large amount of partially reacted material had been sent to the polymer catch tank.

Hot molten plastic inside the polymer catch tank continued to react and also began to slowly decompose, thereby generating gases and causing the contents to foam. The material expanded as foaming continued, and eventually the entire tank was filled. The material then forced its way into connecting pipes, including the normal and emergency vents.

---

Twelve hours prior to the incident, an attempt was made to start the production unit. After approximately 1 hour, the startup was aborted due to problems with the extruder downstream of the reactor—but not before an unusually large amount of partially reacted material had been sent to the polymer catch tank.

---

---

<sup>1</sup> Ownership of the facility was transferred from BP Amoco Polymers, Inc., to Solvay Advanced Polymers, L.L.C., on November 1, 2001, seven months after the incident.

<sup>2</sup> The extruder is a machine composed of turning screws within a stationary barrel. It is used to simultaneously heat, knead, and pump plastic.

---

Once in the pipes, the plastic solidified as it cooled. A hardened layer of plastic 3 to 5 inches thick also formed around the entire inner wall of the tank. However, the core of the plastic mass remained hot and molten, and likely continued to decompose over several hours, generating gases that pressurized the vessel.

Before opening the polymer catch tank, personnel may have relied on a pressure gauge and a transmitter on the vent piping from the vessel to ascertain whether it was under pressure. They also knew that the process was shut down. However, any reading from the pressure gauge would likely have been unreliable because plastic had entered the vent line and solidified.

On previous occasions, the polymer catch tank contained no pressure when it was opened. Varying amounts of plastic were found inside; sometimes the plastic was hot, but it was always solid. Expecting that to be the case again, the workers proceeded to remove the 44 bolts from the cover. When half of the bolts had been removed, the cover suddenly blew off. Hot plastic spewed throughout the area, traveling as far as 70 feet. The cover and the expelled plastic struck the workers, killing them.

The force created by the ejection of gas and plastic propelled the polymer catch tank backward and bent the attached piping. A section of hot oil supply tubing (370 degrees Celsius [ $^{\circ}\text{C}$ ]) for a heating jacket on the inlet line from the reactor knockout pot to the catch tank broke, and the fluid spilled into the area. A flammable vapor cloud formed and ignited within a few minutes. Several hours of firefighting were required to extinguish the fire.

---

## ES.3 Key Findings

1. Operations and technical support staff at the manufacturing site were unaware that Amodel could decompose and generate high pressure when held at elevated temperatures for an extended time.
2. Product performance testing conducted by the company's research and development (R&D) group demonstrated that the plastic was susceptible to thermal decomposition at processing temperatures. However, the manufacturing process was not subjected to a specialized design review to identify hazards from unintended and

---

uncontrolled reactions; and the risks posed by decomposition of the plastic were not recognized.

3. More than the normal amount of hot plastic entered the polymer catch tank during the aborted startup. Reactions and decomposition of the material produced gases, which caused the plastic to foam and expand. The expanded plastic forced its way into connecting pipes, where it solidified and plugged the inlet to the vent line. Once this occurred, the gases could not escape and the vessel became pressurized.
4. Since 1993, there had been several near-miss incidents involving both the polymer catch tank and the waste plastic. Had these incidents been more thoroughly investigated, they could have provided insight into the hazards associated with the operation, as noted below:
  - a. In earlier years, large lumps of solidifying waste plastic had burst, hurtling fragments a considerable distance. Investigations were not thorough enough to determine that the hot, molten material within the lumps was most likely continuing to react and decompose, creating gas and pressure.
  - b. On one occasion after the polymer catch tank was opened, the waste plastic inside spontaneously caught fire. This also happened when a companion vessel was opened. On two other occasions, waste plastic removed from these vessels spontaneously caught fire after being placed in a dumpster. Investigations did not identify that the fires were likely related to the formation of volatile and flammable substances from thermal decomposition of the plastic.
  - c. The polymer catch tank had been overfilled on prior occasions, resulting in plugging of connected piping and the pressure relief device. No adequate measures were developed to prevent recurrence.
  - d. During inspections, the pressure relief device was found to be fouled with solid plastic, which could have rendered it inoperative. The potential consequences of such fouling were not analyzed, and no adequate measures were developed to prevent recurrence.

---

**Operations and technical support staff at the manufacturing site were unaware that [the plastic] could decompose and generate high pressure when held at elevated temperatures for an extended time.**

---

---

**The expanded plastic forced its way into connecting pipes, where it solidified and plugged the inlet to the vent line. Once this occurred, the gases could not escape and the vessel became pressurized.**

---

---

. . . the design of the polymer catch tank did not afford a practical and reliable method for workers to check for hazards before opening the vessel.

---

---

The consequences of the extruder failing to start or shutting down during routine operation were not considered.

---

5. Operating experience revealed that the design of the polymer catch tank did not afford a practical and reliable method for workers to check for hazards before opening the vessel. Drains were often plugged with solidified plastic, making it impossible to verify the absence of pressure or hazardous chemicals in accordance with Occupational Safety and Health Administration (OSHA) lockout/tagout regulations and standard company safety procedures for opening process equipment. Nevertheless, these design deficiencies were not corrected, and no standard practice was developed for preparing the vessel for opening.
6. Process safety information inadequately described the design basis and operating principles for the polymer catch tank. There was no discussion of the means by which overfilling could occur and its consequences.
7. The possibility of overfilling was increased when the original startup procedures were revised; the diversion of output from the reactor to the polymer catch tank was extended from 30 to 50 minutes.<sup>3</sup> This modification of procedures was not subjected to a management of change (MOC) review.
8. Process hazard analyses were inadequate. For example:
  - Credible scenarios for overfilling or pressurizing the polymer catch tank were not recognized.
  - The consequences of the extruder failing to start or shutting down during routine operation were not considered.
  - Reactivity and decomposition hazards were treated inadequately or not at all.
9. Operators had no direct measure of the extent to which the polymer catch tank had been filled. The design for the level detector on the vessel was inadequate.

---

<sup>3</sup> A 1999 training document specified a startup time of 40 to 45 minutes prior to production through the extruder. However, CSB interviews of operators and supervisors indicate with consistency that the practice at the time of the incident was to run for 50 minutes before directing the process flow to the extruder. In prior years, it had been 30 minutes.

- 
10. The failure of the extruder to run forced the startup to be aborted. Although the prestartup checklist called for verification of the operability of the extruder, that procedural check was omitted on this occasion.
- 

## ES.4 Root Causes

1. **Amoco, the developer of the Amodel process, did not adequately review the conceptual process design to identify chemical reaction hazards.**

Neither Amoco's R&D department nor the process design department had a systematic procedure specifically for identifying and controlling hazards from unintended or uncontrolled chemical reactions.

2. **The Augusta facility did not have an adequate review process for correcting design deficiencies.**

The Augusta site was the first and only commercial manufacturing facility for Amodel. Several problems in design of the polymer catch tank became apparent with operating experience. Operations management did not ensure that deficiencies were corrected in a timely manner.

- Workers were unable to follow established company policies for lockout/tagout and equipment opening because the plugged drains on the polymer catch tank prevented them from verifying the absence of pressure in the tank.
- Previous occurrences of overfilling and plastic entrainment into connected piping indicated that the polymer catch tank was too small to handle foreseeable process upsets.
- The level indicating device for the polymer catch tank was unreliable.

3. **The Augusta site system for investigating incidents and near-miss incidents did not adequately identify causes or related hazards. This information was needed to correct the design and operating deficiencies that led to the recurrence of incidents.**

---

Neither Amoco's R&D department nor the process design department had a systematic procedure specifically for identifying and controlling hazards from unintended or uncontrolled chemical reactions.

---

---

Workers were unable to follow established company policies for lockout/tagout and equipment opening because the plugged drains on the polymer catch tank prevented them from verifying the absence of pressure in the tank.

---

---

Incidents and near misses tended to be treated as isolated events.

Management did not have a review system to detect trends and patterns among incidents.

---

- Sound technical theories were not developed to explain the spontaneous ignition of waste plastic or the phenomenon whereby lumps of waste plastic burst.
- Incidents and near misses tended to be treated as isolated events. Management did not have a review system to detect trends and patterns among incidents.
- The polymer catch tank had been overfilled and the vent lines plugged on other occasions. No effective measures were developed to prevent recurrence.
- Fires occurred at the extruder on numerous occasions. No effective countermeasures were developed.

---

## ES.5 Contributing Causes

---

Reactivity hazards, such as unintended reactions, were not examined in the final design-phase hazard analysis.

---

1. **Hazard analyses of the Amodel process were inadequate and incomplete.**
  - Reactivity hazards, such as unintended reactions, were not examined in the final design-phase hazard analysis.
  - The extruder operation and its overall impact on the rest of the process were not adequately reviewed during the formal hazard analysis conducted during design and construction.
  - Credible scenarios by which the polymer catch tank could become overfilled were not identified.
2. **Design documentation did not adequately describe the Amodel process.**
  - The process description did not adequately explain the design basis and operating principles for the polymer catch tank; as a result, misunderstandings of these characteristics developed. The maximum fill level was not clearly specified. No warnings were provided about the consequences of overfilling.
  - Operations management did not update the documentation to reflect changes in procedures and practices.
3. **Equipment opening procedures did not specify what actions to take when safety precautions could not be met.**

---

On the day of the incident and frequently during the life of the Amodel process, it was not possible to verify the absence of pressure in the polymer catch tank, as required by company procedures and OSHA lockout/tagout regulations. Solid polymer plugged the drain nozzles, which should have been used to verify the absence of pressure. Without a policy requiring management review and authorization in such circumstances, workers proceeded to open the vessel despite the lack of positive verification that it was not pressurized.

---

On the day of the incident and frequently during the life of the Amodel process, it was not possible to verify the absence of pressure in the polymer catch tank, as required by company procedures and OSHA lockout/tagout regulations.

---

**4. Revisions to operating procedures were not subjected to management of change reviews to evaluate safety effects.**

Flow was originally directed to the polymer catch tank for 30 minutes during startup. Without adequate consideration of possible adverse consequences, this time was later extended to 50 minutes—which increased the amount of material to be disposed of to the vessel.

---

## ES.6 Recommendations

---

### Solvay Advanced Polymers, L.L.C.

1. Examine the manufacturing businesses acquired from BP Amoco Performance Polymers and ensure that a systematic safety review procedure is developed and implemented for identifying and controlling hazards from unintended chemical reactions. Additionally, ensure that reactive hazards are identified and evaluated:
  - During product R&D, during conceptual design of a new process, and during detailed design of a new process.
  - Before changes are made to existing equipment or process chemistry.

Communicate the results of this review to the workforce.

2. Ensure that a program is in place at facilities acquired from BP Amoco Performance Polymers to systematically review the hazards associated with new and modified processes and equipment as

---

operating experience accrues. Ensure that facilities correct all identified design, operation, and maintenance deficiencies. Verify that operating experience does not invalidate the design basis for equipment.

3. Revise the Material Safety Data Sheet (MSDS) for Amodel to warn of the hazards of accumulating large masses of molten polymer. Communicate the MSDS changes to current and past customers (who may retain inventories of this product).

---

## Solvay Advanced Polymers, L.L.C., Augusta Facility

1. Implement a program to conduct periodic management reviews of incidents and near-miss incidents. Look for trends and patterns among incidents. Address root causes and implement and track corrective measures.
2. Revise process safety information to include:
  - Information regarding the decomposition reactions of Amodel.
  - Design intent, basis, capacity, and limitations of equipment.
  - Hazards and consequences of deviations from design intent and operating limits.
3. Revalidate hazard analyses for the Amodel process to address:
  - Credible deviations from process intent and their consequences.
  - Hazards associated with startup and shutdown operations.
  - Prevention of accumulations of potentially hazardous masses of polymer.



- 
4. Revise your lockout/tagout program to ensure that equipment is rendered safe prior to opening for maintenance. At a minimum, ensure that equipment opening procedures contain a stop work provision that requires higher levels of management review and approval when safe opening conditions, such as equipment depressurization, cannot be verified.
  5. Ensure that your management of change policy applies to operational and procedural modifications.

---

## BP Chemicals Group

Communicate the findings of this report to your chemical and plastics manufacturing facilities in North America.

---

## American Chemistry Council Society of Plastics Engineers

Communicate the findings of this report to your membership.



---

# 1.0 Introduction

---

On March 13, 2001, at approximately 2:40 am, three workers were fatally injured when pressurized material was suddenly expelled from the polymer catch tank (KD-502) at the BP Amoco Polymers plant in Augusta, Georgia. The two operators and one maintenance technician were attempting to remove a cover from the catch tank, expecting to extract hardened plastic. After half of the 44 bolts had been removed, pressure inside the vessel caused the remaining bolts to break and the cover to fly off. The workers were struck by the cover and the expelled plastic. All three men were employees of BP Amoco.

The U.S. Chemical Safety and Hazard Investigation Board (CSB) launched an investigation to determine root and contributing causes and to issue recommendations to help prevent similar occurrences.

---

CSB investigators examined physical evidence at the scene, took samples, conducted interviews with current and former employees of Amoco and BP Amoco, and reviewed company documents and scientific literature. CSB also arranged for experiments to be performed at two plastic testing laboratories.

---

The BP Amoco facility is located on a 100-acre site in Augusta, Georgia, and produces various specialty plastics. It employs approximately 250 full-time personnel. Amodel—the trade name for the product involved in this incident—is a high-performance nylon thermoplastic<sup>1</sup> used for automotive, electronic, consumer, and medical device applications.

The manufacturing site was initially developed by Dartco Manufacturing in 1984. Amoco purchased the facility in 1988 and constructed the first Amodel process there in 1992. In 1998, Amoco and British Petroleum merged to form BP Amoco. In November 2001, BP Amoco and Belgium-based Solvay SA completed an asset exchange; the Augusta site and associated business were transferred to Solvay Advanced Polymers, L.L.C.

---

<sup>1</sup> Nylon is a type of plastic characterized by the chemistry of repeating amide groups. Thermoplastic is a plastic that melts when heated.

## 1.1 Background

## 1.2 Investigative Process

## 1.3 BP Amoco Polymers Augusta Facility

---

## 1.4 History of Process Development

Amoco initiated development of the process for making Amodel in the early 1980s. A pilot plant<sup>2</sup> built in Naperville, Illinois, was the company's first manufacturing effort for a nylon plastic.

In 1987, a semiworks<sup>3</sup> production facility (also referred to as the "experimental unit") was built in Greenville, South Carolina. In 1990, the advanced polymers and fibers research and development (R&D) organization and the pilot plant were relocated from Naperville to Alpharetta, Georgia. A semiworks unit was then constructed on the Augusta site. It commenced operation in 1992, and was followed a year later by the company's first and only commercial production unit.

Amoco was the recipient of several patents for the Amodel manufacturing process.

---

<sup>2</sup> A pilot plant is a small-scale manufacturing plant used to evaluate a new process technology.

<sup>3</sup> A semiworks production facility is larger than a pilot plant, but smaller than a commercial production unit. The purpose of a semiworks facility is to produce product samples for commercial purposes.

---

## 2.0 Process Description

---

### 2.1 Chemistry

A model is a polymer<sup>4</sup> prepared by the reaction of an aliphatic di-amine with aromatic and aliphatic di-carboxylic acids. It is referred to as a polyphthalamide nylon because it is derived from isophthalic and terephthalic acids.

When dissolved and heated in the presence of a catalyst, the raw materials react and combine to form a molecular chain. With each addition to the chain, a molecule of water is formed as a byproduct. An equilibrium exists between the forward and reverse reactions, represented as:

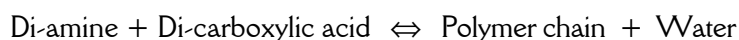

The polymerization reaction occurs in a liquid solution and is mildly exothermic.<sup>5</sup> The water created is ultimately converted to steam because the reaction is conducted at high temperature. The vaporizing water absorbs energy released by the reaction. If the energy required to form the steam is taken into account, the overall reaction is considered to be slightly endothermic.<sup>6</sup>

---

<sup>4</sup> A polymer is a natural or synthetic chainlike molecule formed by the union of at least five identical smaller molecules (monomers). Polymers usually contain many more than five monomers, and some may contain hundreds or thousands of monomers in each chain.

<sup>5</sup> An exothermic reaction is characterized by the release of energy.

<sup>6</sup> An endothermic reaction is characterized by the consumption of energy.

## 2.2 Process Configuration

Figure 1 is a highly simplified sketch of the process for making Amodel.

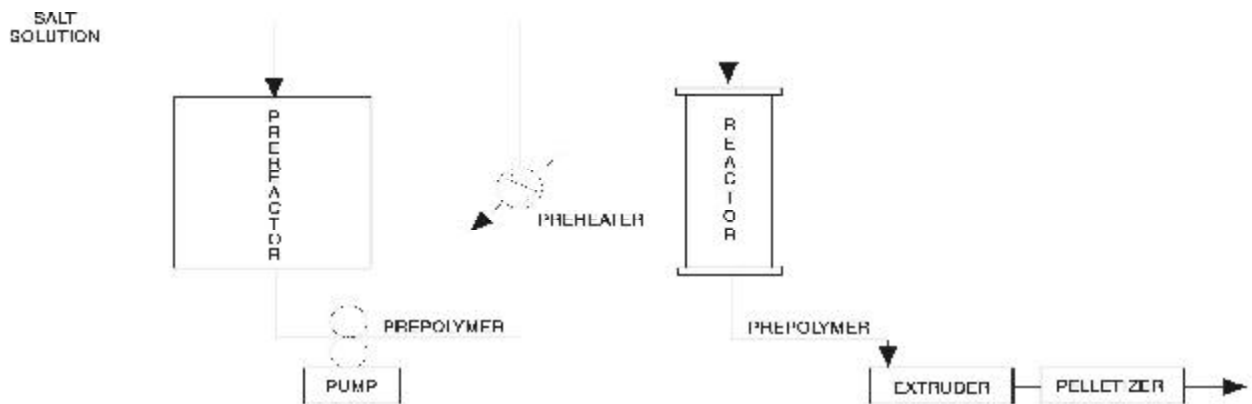

Figure 1. Highly simplified flow diagram for Amodel production.

Because the chemicals used to make the plastic are solids at ambient temperature, the first step in the process is to dissolve them. The result is a salt solution of raw materials that is then fed to a pressurized prereaction vessel, where the temperature is increased to between 190 and 230 degrees Celsius ( $^{\circ}\text{C}$ ). The reaction proceeds partially at this stage to form a prepolymer.<sup>7</sup>

A high-pressure pump sends the prepolymer forward to the preheater, where the temperature is raised to between 290° and 340°C. The increasing temperature further advances the reaction. The solution then passes through a flow orifice to decrease pressure, which causes some of the water in the solution to rapidly vaporize to steam.

<sup>7</sup> Prepolymer has a molecular weight lower than the finished product.

---

The dispersion of prepolymer and steam is then fed to a tubular reactor, where the temperature is increased still further. The process fluid remains in the reactor for less than a minute. When it exits, the overall reaction is more than 80 percent complete.

An extruder<sup>8</sup> finishes the reaction to a polymer of the desired molecular weight. The product from the extruder is then pelletized, cooled, and stored.

---

During normal process operation, the prepolymer produced in the reactor is fed to the extruder. During periods of startup and shutdown, and when there are mechanical difficulties with the extruder, the reactor effluent is diverted to a waste collection vessel—referred to as the polymer catch tank (Figures 2 and 3). The catch tank is a 750-gallon horizontal cylindrical steel vessel with a flat cover bolted to each end. Before startup, it is empty except for a removable branched metal frame that serves as a surface on which polymer agglomerates.

The polymer catch tank acts as a chamber for separating prepolymer from vapor. The rapidly flowing process stream from the reactor enters the catch tank through a 4-inch pipe nozzle located on one of the end covers. The velocity of the stream decreases as it enters, causing liquid droplets of polymer to fall and settle inside the vessel. The prepolymer accumulates in the vessel; the vapor portion of flow exits through a 6-inch vent nozzle located on top of the cylindrical shell.

Three other piping connections are located on top of the polymer catch tank. One is used for the pressure relief device. The other two are utility connections for nitrogen and service water, which can be used for purging and flushing the vessel.

---

## 2.3 Polymer Catch Tank and Reactor Knockout Pot

---

**During periods of startup and shutdown, and when there are mechanical difficulties with the extruder, the reactor effluent is diverted to a waste collection vessel—referred to as the polymer catch tank.**

---

---

<sup>8</sup> An extruder is a machine consisting of turning screws within a stationary barrel. It is used to simultaneously heat, knead, and pump plastic.

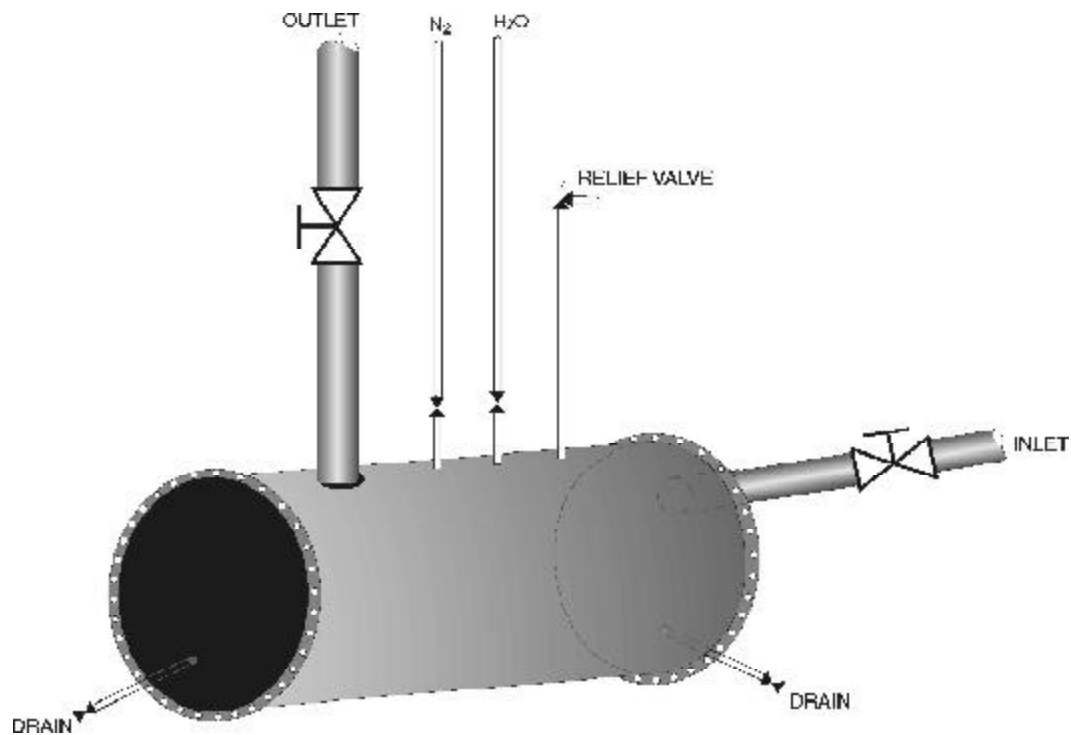

Figure 2. KD-502 polymer catch tank (simplified representation).



Figure 3. KD-502 polymer catch tank (actual vessel with one cover removed).



The material that enters the polymer catch tank from the reactor is hot; because the tank is neither heated nor cooled, the rate of cooling depends on a number of factors, including the total amount of material present and ambient conditions.

Typically, during startup of the process, the effluent from the reactor is ~~directed to the polymer catch tank for 50 minutes~~ before being diverted to the extruder (Figure 4). Prepolymer that accumulates inside the catch tank during startup normally cools and solidifies.

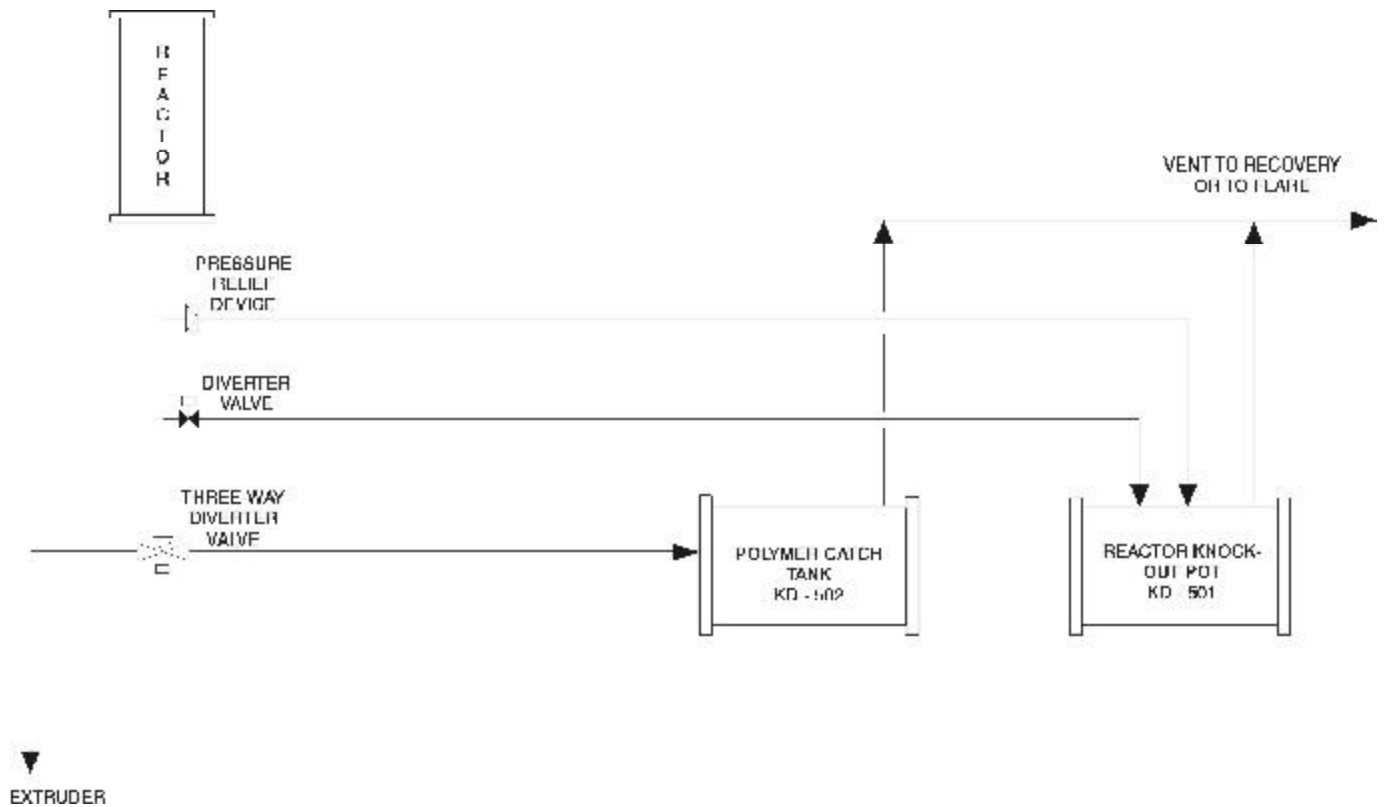

Figure 4. Simplified process diagram showing polymer catch tank and reactor knockout pot.

<sup>9</sup> A 1999 training document specified a startup time of 40 to 45 minutes prior to production through the extruder. However, CSB interviews of operators and supervisors indicate with consistency that the practice at the time of the incident was to run for 50 minutes before directing the process flow to the extruder.

---

When the manufacturing process is shut down, the flow of raw materials is discontinued; a solvent is used to displace and dissolve the prepolymer. Early in this stage, the flow from the outlet of the reactor continues to be directed to the extruder. Once solvent is detected at the extruder, the flow from the reactor is diverted to the polymer catch tank.

The solvent is capable of dissolving polymer residues in the reactor, piping, and associated systems. As the solution of polymer approaches the polymer catch tank, the pressure decreases and the solvent vaporizes almost completely upon reaching the tank. Inside, prepolymer separates from the vaporized solvent and settles as a liquid on top of the typically solid residue of startup material already present. The solvent vapors exit through a vent line on top of the tank. The amount of prepolymer added to the vessel during a normal shutdown is small compared to the amount sent during startup.

Further flushing of the equipment with water and steam completes the shutdown. Both the solvent flush and the water flush also remove heat from the polymer inside the polymer catch tank; the plastic typically solidifies. Later, one of the covers is removed from the tank, and the accumulated solid waste on and around the metal frame is pulled out and disposed of.

The reactor knockout pot (KD-501) is a waste vessel very similar in design to the polymer catch tank. Figure 4 depicts its arrangement and connectivity to the process. The emergency pressure relief devices at the outlet of the reactor discharge to the knockout pot. The reactor effluent can be directed to the knockout pot when the catch tank is too full.

---

## 3.0 Description of Incident

---

The Amodel unit operated normally during the week prior to the incident. However, it was shut down on Saturday, March 10, 2001, for repair of an equipment failure in the extruder. Restart was scheduled for March 12.

As was typical following a shutdown, during the early morning hours of March 11, the polymer catch tank was prepared for opening and the cover was removed. The frame inside was extracted, and the tank was cleaned of accumulated polymer. Maintenance personnel reported that the vessel appeared to be clean and in good condition. The cover was subsequently closed and rebolted.

Although the polymer catch tank was designed to have a level detector, the device was often damaged during cleanout of hardened polymer. There was no level detector in the vessel when it was closed on March 11.

### 3.1 Pre-Incident Events

---

Although the polymer catch tank was designed to have a level detector, the device was often damaged during cleanout of hardened polymer. There was no level detector in the vessel when it was closed on March 11.

---

---

#### 3.1.1 Attempted Startup

Operators commenced prestart checks on March 12 at 6:45 am. The lead operator was told that the extruder had been run the night before with a purge material to clean the screws. Data confirm that the extruder was purged at 2:19 am on March 12. The lead operator thought that it was not necessary to repurge the extruder, and his supervisor agreed.

As part of the normal startup checklist, the extruder was to be prerun for at least 1 to 2 minutes to verify operability before startup of the reaction section of the process. This activity was not identified as complete on the checklist, and control system logs show no data indicating that the extruder was prerun, in accordance with procedure, from the time it was purged early on the morning of March 12 until the failed startup attempt.

Raw material feed was introduced to the reaction section of the unit at 1:29 pm on March 12. Temperatures and pressures were within normal ranges. As specified by standard procedure, the initial polymer produced was directed to—and began to accumulate in—the polymer catch tank. The procedure called for this mode of operation to continue for 50 minutes before the flow of material from the reactor was

---

Over the next 25 minutes, personnel made several attempts to diagnose and resolve the problem [with the extruder]. During this time, molten polymer continued to be directed to the polymer catch tank.

---

diverted from the catch tank to the extruder. To finalize startup, operators attempted to start the extruder at 2:17 pm, and it was discovered that the screws would not turn.

Unit supervisors and the production coordinator were present at the unit during the attempted startup, and they were immediately notified of the extruder problem. Maintenance was called to assist. Over the next 25 minutes, personnel made several attempts to diagnose and resolve the problem. During this time, molten polymer continued to be directed to the polymer catch tank.

---

### 3.1.2 Aborted Startup

At 2:35 pm on March 12, with the extruder malfunction still unresolved, supervision made a decision to abort the startup. Operators stopped the flow of raw materials to the reaction line. Flushing solvent was injected at 2:41 pm to begin cleaning the piping and equipment of accumulated polymer. Because the extruder was not operating, the molten polymer continued to accumulate in the polymer catch tank.

The flushing operation continued normally until approximately 3:45 pm, at which time an engineer noticed vapor leaking from the top of the bolted cover on the polymer catch tank between the 11 and 2 o'clock positions. Plant personnel described the leaking vapors as characteristic of the solvent.

Supervision was made aware of the leak, and a decision was made to divert the process flow from the polymer catch tank to the adjacent reactor knockout pot. This was accomplished at approximately 3:55 pm. From this point until 2:40 am on March 13—when the incident occurred—no additional material entered the catch tank.

---

Shortly after flow was diverted to the reactor knockout pot, it too began to leak vapor from its cover. At 6:53 pm on March 12, the solvent flush was completed, and water was circulated through the unit. The water passed through the knockout pot in the form of steam. Because the polymer catch tank had been bypassed earlier, the hot polymer inside did not receive any cooling that the steam flush could have provided. Operators continued to monitor temperatures and pressures for the next several hours. At 11:21 pm, the water flush was discontinued, completing the shutdown.

---

### 3.1.3 Preparation for Removal of Polymer Catch Tank Cover

Instructions were left for the night shift to empty the polymer catch tank and the reactor knockout pot of polymer that had accumulated during the aborted startup. A maintenance technician arrived at 2:15 am on March 13 to do the work.

Operators closed the valves that supplied nitrogen to the two vessels and placed energy isolation tags on them. Other than the nitrogen line, no connections to the polymer catch tank were locked or tagged. It is unknown whether an attempt was made to use the drain valves on the tank to ascertain the absence of pressure or liquid inside.

~~An equipment isolation list~~<sup>10</sup> was filled out by the operator and signed by the operator and the maintenance technician. Two operators accompanied the maintenance technician to the catch tank to assist with opening and cleaning it.

---

**Other than the nitrogen line, no connections to the polymer catch tank were locked or tagged.**

---

---

<sup>10</sup> The equipment isolation list is a written record describing the devices used to de-energize and secure a machine, equipment item, or system prior to the commencement of maintenance activities. The devices may include valves, controls, electrical switchgear, locks, and warning tags.

---

## 3.2 Incident Description

---

The 1,750-pound cover blew off the polymer catch tank . . . A mass of hot plastic was ejected from the 48-inch-diameter tank opening.

---



Figure 5. Damaged girder.

---

### 3.2.1 Cover Failure and Expulsion of Hot Plastic

Forty-four 1 1/8-inch bolts<sup>11</sup> were secured around the circumference of the flanged cover of the polymer catch tank. At 2:25 am on March 13, with the assistance of two operators, the maintenance technician began removing bolts with a pneumatic impact wrench. The removal of each bolt gradually reduced the restraining capacity of the cover. At 2:36 am, after 22 of the bolts had been removed—ranging from the 1:30 to 7:30 o'clock position on the cover—the remaining bolts suddenly broke, resulting in an explosive release of pressure.

The 1,750-pound cover blew off the polymer catch tank, flying upward and to the north. After striking a girder<sup>12</sup> on the overhead rain canopy, the cover landed approximately 14 feet from its original position (Figures 5 and 6). A mass of hot plastic was ejected from the 48-inch-diameter tank opening. The material struck the three workers and scattered widely.

Witnesses described the subsequent formation of a plume of white smoke or steam in the Amodel unit, but no visible fire after the first explosion. The maintenance technician and both operators suffered severe impact trauma. Two men died at the scene, and the other was pronounced dead on arrival at the Medical College of Georgia.

---

### 3.2.2 Subsequent Fire

The force created by the rapid expulsion of material from the polymer catch tank propelled it backward, causing the attached piping to bend. A section of hot oil supply tubing for a heating jacket on the inlet line to the catch tank broke; the hot oil escaped and formed a vapor cloud, which ignited at 2:42 am.

---

<sup>11</sup> The bolts were actually 1 1/8-inch threaded studs with nuts welded on one end.

<sup>12</sup> A girder is a horizontal structural member used to stiffen the frame of a building.



Figure 6. Polymer catch tank cover.

Witnesses who responded to the sound of the first explosion described the second event as a large orange fireball. Following the initial flash, the release of hot oil continued to feed the fire, which burned for several hours in an area behind the polymer catch tank.

---

### 3.2.3 Emergency Response

Following the initial explosion, the plant emergency response team, the plant fire brigade, and the Richmond County Fire Department responded to the incident.

The area water deluge system and manual hose streams were used to control the fire. The victims were recovered, and cardiopulmonary resuscitation (CPR) was administered to one of them. After emergency responders isolated the hot oil system, the fire was extinguished at about 8:15 am on March 13.

---

## 3.3 Reconstructive Analysis

---

When the extruder experienced certain mechanical difficulties, it was necessary to divert the reactor effluent and to accumulate polymer in the polymer catch tank or the reactor knockout pot. On at least two prior occasions, this resulted in overfilling one of the two vessels and plugging their common vent line.

---

---

. . . a solid layer of polymer 3 to 5 inches thick remained in the vessel and coated the entire inside surface, including the rear cover. The vessel nozzles, including the vent nozzle, were completely plugged with polymer.

---

---

### 3.3.1 Extruder Failure

Inspection of the extruder after the incident revealed that significant quantities of ash had accumulated inside it. As described in Appendix A, the ash was most likely the result of an internal fire involving residual purging material. (A small fire had been observed at the extruder during the early morning hours of March 12.) Because the extruder was not designed to convey powders, the accumulated ash probably caused the screws to bind when attempts were made to start the machine later that afternoon.

Statements from several operators indicated that this was the first time the extruder failed to run coincidentally with a startup of the reaction section. However, the machine or its components were known to occasionally fail during routine operation. It was an extruder component failure during a production run that resulted in the plant shutdown on March 10. In early February 2001, a 2-day series of instrument failures on the extruder motor also culminated in shutdown of the process.

BP Amoco personnel were aware of the possibility of extruder malfunctions during production, whatever the cause. When the extruder experienced certain mechanical difficulties, it was necessary to divert the reactor effluent and to accumulate polymer in the polymer catch tank or the reactor knockout pot. On at least two prior occasions, this resulted in overfilling one of the two vessels and plugging their common vent line.

---

### 3.3.2 Polymer Catch Tank

Investigators found that most of the contents of the polymer catch tank were expelled during the incident. However, a solid layer of polymer 3 to 5 inches thick remained in the vessel and coated the entire inside surface, including the rear cover (see cover photograph). The vessel nozzles, including the vent nozzle, were completely plugged with polymer (Figure 7). Significant amounts of polymer were found in the vent system. Appendix A provides a more extensive discussion of the physical evidence.





Figure 7. Polymer plugging the polymer catch tank vent nozzle.

During a typical startup, the amount of prepolymer sent to the polymer catch tank filled less than half the vessel. As a result of the aborted startup on March 12, more than twice the normal amount of hot prepolymer was directed to the tank;<sup>13</sup> this had not occurred uninterruptedly on any previous occasion. Consequently, the amount of thermal energy inside the vessel was most likely greater than it had ever been before.

The properties of Amodel make it an effective insulator.<sup>14</sup> Although the plastic near the walls of the polymer catch tank cooled and solidified, the core likely remained hot and molten for an extended time. As the vessel filled beyond its working capacity, its capability to separate the incoming vapor from molten prepolymer decreased. Polymer droplets likely became entrained within the vapor stream, left the vessel, and escaped into the vent system,<sup>15</sup> where they could be expected to deposit on the pipe walls and harden.

---

As a result of the aborted startup on March 12, more than twice the normal amount of hot prepolymer was directed to the tank . . .

---

---

Although the plastic near the walls of the polymer catch tank cooled and solidified, the core likely remained hot and molten for an extended time. As the vessel filled beyond its working capacity, its capability to separate the incoming vapor from molten prepolymer decreased.

---

---

<sup>13</sup> This included the prepolymer made during startup and produced during extruder troubleshooting, plus the hot material displaced from the reaction section of the plant during the solvent flush following the decision to abort the startup.

<sup>14</sup> Amodel readily solidifies; the solid polymer resists the transmission of heat.

<sup>15</sup> Appendix A provides further details on the mechanism of polymer entrainment.

---

Continued accumulation of polymer in the piping likely created a partial blockage that ultimately restricted the flow of vapor through the vent system. This restriction probably caused the polymer catch tank to become pressurized during the solvent flush. The accumulated pressure in the tank exceeded the sealing capability of the bolted joint between the 4-foot-diameter cover and the vessel flange, which explains why solvent vapor leaked from the top of the cover at 3:45 pm on March 12.

Although flow was restricted, it is unlikely that the vent line was completely plugged off at this time because solvent continued to flow through the system and the polymer catch tank. However, plugging in the vent system was extensive and continued to worsen even several hours after the solvent flush was discontinued.

The emergency pressure relief valve on the reactor knockout pot finally activated<sup>16</sup> during water flushing operations at approximately 8:10 pm on March 12. It is probable that increased plugging in the common vent piping eventually created an obstruction substantial enough to cause the back pressure in the knockout pot to exceed the set pressure of the relief valve.

---

. . . these reaction characteristics led CSB investigators to conclude that the source of pressure inside the polymer catch tank was gas formation due to unintended chemical reactions.

---

---

### 3.3.3 Physical Testing and Chemistry

The public literature on nylon plastics describes them as susceptible to thermal degradation and side reactions. Both mechanisms produce gases, which can include carbon dioxide, ammonia, and water vapor. Together with other evidence, these reaction characteristics led CSB investigators to conclude that the source of pressure inside the polymer catch tank was gas formation due to unintended chemical reactions. Appendix A provides further details on the chemical testing conducted by CSB.

---

<sup>16</sup> From 6:53 to 11:21 pm on March 12, water was circulated through the unit and steam was vented through the reactor knockout pot, which shares vent piping with the polymer catch tank.

---

As part of its investigation, CSB arranged for testing of typical extruded Amodel. One sample was tested by thermogravimetry<sup>17</sup> under conditions similar to those expected in the interior of the polymer catch tank (i.e., 315°C for up to 12 hours). The tests revealed that Amodel undergoes a significant weight loss at these conditions. CSB concludes that the weight loss is due partly to decomposition of the plastic and partly to side reactions. Further testing using an accelerating rate calorimeter (ARC)<sup>18</sup> provided other significant evidence of the thermal decomposition potential of the plastic (Appendix A).

Samples were also taken from the layer of hardened plastic found on the inside wall of the polymer catch tank. Tests carried out by BP Amoco indicated that the polymer chains were highly branched, which is strong evidence that side reactions occurred inside the vessel in addition to decomposition.

The company also analyzed the vapors generated when Amodel was heated to 340°C. Significant concentrations of carbon monoxide, carbon dioxide, ammonia, and water were found—all of which are consistent with decomposition or side reactions. These substances are gases at moderate temperatures and would develop pressure in a closed vessel.

---

**Further testing using an accelerating rate calorimeter provided other significant evidence of the thermal decomposition potential of the plastic.**

---

---

**Significant concentrations of carbon monoxide, carbon dioxide, ammonia, and water were found—all of which are consistent with decomposition or side reactions. These substances are gases at moderate temperatures and would develop pressure in a closed vessel.**

---

---

### 3.3.4 Vessel Pressurization

No additional material flowed into the polymer catch tank after 3:55 pm on March 12. Over the next several hours, reactions in the core of the vessel most likely generated vapor—thus causing the viscous, molten contents to foam and expand, occupying the entire volume of the catch tank. Further expansion likely pushed the material through the tank nozzles, and into the vent line and the emergency pressure relief inlet—fully blocking them. As polymer reached the sides and upper

---

**No additional material flowed into the polymer catch tank after 3:55 pm on March 12. Over the next several hours, reactions in the core of the vessel most likely generated vapor—thus causing the viscous, molten contents to foam and expand . . .**

---

---

<sup>17</sup> Thermogravimetry is a method of measuring the change in mass of a substance on heating. Losses of mass may be due to dehydration, decomposition, desorption, vaporization, or chemical reactions that create gaseous products.

<sup>18</sup> ARC is a trademark of Arthur D. Little, Inc.

---

surfaces of the vessel, it tended to cool and solidify.<sup>19</sup> It also cooled and solidified in the nozzles and connected pipes. Once this occurred, the evolving vapor had no escape pathway and it pressurized the catch tank.

---

<sup>19</sup> Although the polymer catch tank was insulated, it was not heated. Heat losses to the environment would cause the polymer to solidify.

---

## 4.0 Analysis of Incident

---

**B**P Amoco Augusta site operations and technical support personnel were unaware of the potential for a hazardous decomposition reaction in the Amodel process. It was widely believed that no additional reactions occurred once material was sent to the polymer catch tank.

Following the March 13, 2001, incident, however, investigators theorized that chemical reactions likely occurred in the polymer catch tank, though it was not readily apparent which specific reaction mechanisms led to the accumulation of hazardous pressure. Chemical testing conducted after the incident confirmed that crosslinking and decomposition reactions likely caused the pressure accumulation.

CSB investigators interviewed R&D chemists and engineers involved in the Amodel project from its inception in the early 1980s. The development team did not conduct any research into the hazards of normal or unanticipated reactions in the Amodel process.<sup>20</sup> Amoco did not have a policy or procedure for such reviews in product research, process development, or engineering design of a manufacturing process.<sup>21</sup>

The design of the Amodel process predates publication of the Institution of Chemical Engineers' (IChemE) Chemical Reaction Hazards, A Guide to Safety. However, this guidebook states:

... it is essential to allocate responsibilities and establish procedures for the following key stages of assessing chemical reaction hazards:

- defining process chemistry/operating conditions;
- investigating potential chemical reaction hazards;
- selecting and specifying safety measures;
- implementing and maintaining safety measures (Barton and Rogers, 1997; p. 14).

---

<sup>20</sup> Such research typically includes literature search, screening calorimetry, and—as needed—more sophisticated calorimetry of both intended and unintended reactions to examine potentially hazardous releases of energy or gaseous byproducts.

<sup>21</sup> Procedures for evaluating reactive hazards are described in Guidelines for Chemical Reactivity Evaluation and Application to Process Design (CCPS, 1995a), Guidelines for Safe Storage and Handling of Reactive Materials (CCPS, 1995b), Chemical Reaction Hazards, A Guide to Safety (Barton and Rogers, 1997), and Designing and Operating Safe Chemical Reaction Processes (HSE, 2000). Note: Although these guidelines were not available at the time the Amodel process was designed, they are based, in part, on industry practices established in the 1980s.

---

### 4.1 Reactive Chemical Hazard Management

---

**BP Amoco Augusta site operations and technical support personnel were unaware of the potential for a hazardous decomposition reaction in the Amodel process. It was widely believed that no additional reactions occurred once material was sent to the polymer catch tank.**

---

**Chemical testing conducted after the incident confirmed that crosslinking and decomposition reactions likely caused the pressure accumulation.**

---

---

... Amodel decomposes and produces significant quantities of gaseous byproducts when held at or near its melting temperature for an extended time.

---

---

... on BP Amoco's larger commercial production scale, a buildup of gaseous byproducts led to the catastrophic March 13 incident, which demonstrates that even slow, endothermic reactions can result in serious hazards.

---

As discussed in Appendix A, publicly available literature describes potential decomposition and crosslinking reactions of nylon-family polymers. If such literature had been carefully studied and a more extensive hazards identification review undertaken, BP Amoco would have likely discovered that Amodel decomposes and produces significant quantities of gaseous byproducts when held at or near its melting temperature for an extended time.

Had this information been known to the process development team, they may have designed the Amodel process in such a way as to minimize or eliminate the large-scale accumulation of molten polymer, thus preventing this type of reactive incident. Such accumulation contributed not only to the March 13 incident, but also to other incidents involving burning or exploding waste polymer.

Accelerating rate calorimetry (Appendix A) shows that Amodel decomposes and forms gaseous byproducts at temperatures below 349°C, albeit slowly and in an endothermic manner (i.e., heat absorbing). Guidelines for Safe Storage and Handling of Reactive Materials describes the hazards of slow gas-forming reactions:

Numerous process incidents have occurred in closed systems where evolution of gas over time has caused pressure to build up in the system to the point of containment failure (CCPS, 1995b; p. 22).

This phenomenon is not likely to represent a serious hazard when only small quantities of polymer are handled. However, on BP Amoco's larger commercial production scale, a buildup of gaseous byproducts led to the catastrophic March 13 incident, which demonstrates that even slow, endothermic reactions can result in serious hazards.

In 1990 and again in 1994, Amoco's R&D function conducted thermogravimetric tests of Amodel in support of product application technology. The purpose of the tests was to examine ways to minimize plate-out,<sup>22</sup> a phenomenon in injection molding machines.<sup>23</sup> The 1994 study demonstrated that, when heated to 335°C for 8 minutes, Amodel

---

<sup>22</sup> Plate-out refers to unwanted material accumulation on the open faces of extrusion dies. Because this buildup can interfere with molding, the processing line must be shut down periodically to clean the die (Gander and Giacomini, 1997).

<sup>23</sup> Injection molding machines are used to extrude and mold raw plastic into finished parts.

---

polymers slowly degrade<sup>24</sup> and produce volatile compounds that can interfere with product quality.

The significance of this information with respect to process safety was not recognized. Amoco did not apply its findings beyond product application bulletins—except for the Material Safety Data Sheet (MSDS) for Amodel (various grades), which states that the product is stable to 349°C and recommends avoiding higher temperatures to prevent thermal decomposition. This threshold is slightly higher than the highest temperature in the manufacturing process.

In 1990, an Amoco corporate engineer at the Naperville, Illinois, research center convinced management of the need for a thermophysical properties laboratory to conduct sophisticated testing on chemical reactions. Although Amoco made a commitment to the personnel and equipment needed to evaluate reactive hazards, no complementary supporting policies and programs were developed to guide business units.

The laboratory ultimately conducted little or no work on Amoco processes and products. When the engineer retired in 1995, Amoco donated the testing equipment to a university research institute.

---

## 4.2 Process Safety Information

The Augusta workforce was unaware of important principles of operation for the polymer catch tank, which were absent from the documented process safety information. For example:

- Design information did not explain that the catch tank was required to serve as a separator. Critical parameters that affect separator performance, such as maximum operating level, were not identified.
- The design documentation stated that the catch tank would be used during flushing operations, but did not describe its other required roles for startup and process upsets. It was stated that the vessel would fill up in about an hour at a specified flow rate, but there was no explanation of how much material was expected

---

**The Augusta workforce was unaware of important principles of operation for the polymer catch tank, which were absent from the documented process safety information.**

---

---

<sup>24</sup> The degradation rate was less than 0.05 percent per minute or 3 percent per hour.

---

Operating limits for a maximum level in the catch tank were not provided, nor were the consequences of operating at abnormal conditions. Because the vessel also acted as a separator, operation beyond a certain level entrained liquid plastic into the vent line.

---

[Process safety information] preserves a record of design conditions and materials of construction for existing equipment, which helps ensure that operation and maintenance remains faithful to the original intent.

---

to collect during each stage of operation. There was no guidance on how much space to leave in the vessel to ensure adequate capacity for upset conditions.

- No information described the potential for foaming, even though the solidified waste plastic routinely removed from the catch tank appeared to be foamy. Foaming altered the density of the material.

Investigators noted that most plant technical personnel were surprised that the vessel overflowed during the attempted and aborted startup. When offering potential explanations to investigators, they referred to the density of pure Amodel when accounting for their calculations. They did not recognize that foaming could lower the density of the plastic. (At a constant mass flow rate, a lower density material more quickly fills a vessel.)

- Operating limits for a maximum level in the catch tank were not provided, nor were the consequences of operating at abnormal conditions. Because the vessel also acted as a separator, operation beyond a certain level entrained liquid plastic into the vent line.

On the day of the incident, the polymer catch tank was filled beyond its working capacity. Its performance as a separator diminished, allowing liquid plastic to be carried along with vapors into the vent line. Although foaming of the hot molten polymer in the core of the vessel ultimately caused the vent and emergency lines to plug off completely, overflowing was a contributing factor.

The Center for Chemical Process Safety (CCPS), an industry-sponsored affiliate of the American Institute of Chemical Engineers (AIChE), identifies process safety information (also referred to by CCPS as “documentation of process knowledge”) as one of the 12 elements of chemical process safety management. This element includes such information as process and equipment design criteria.

CCPS (1989) cites several reasons for preserving process safety information and making it available within the company, as noted below:

- It provides a basis for understanding how the process should be operated and why it should be run in a given way.



- 
- It preserves a record of design conditions and materials of construction for existing equipment, which helps ensure that operation and maintenance remains faithful to the original intent.
  - It allows recall of the rationale for key design decisions during major capital projects, which is useful for a variety of reasons, such as future projects and modifications.
  - It offers a “baseline” for evaluating process change.

The limited information provided in Amoco’s process safety information for the polymer catch tank was inadequate to inform personnel of the consequences of operating outside the original design intent. The excessive accumulation of molten polymer, which contributed to the March 13 incident, would have been less likely if process safety information had been more complete.

---

**The limited information provided in Amoco’s process safety information for the polymer catch tank was inadequate to inform personnel of the consequences of operating outside the original design intent.**

---

---

During the mid to late 1990s, the time that startup material was directed to the polymer catch tank was increased from 30 to 50 minutes. For the first 20 minutes, the startup material primarily consists of water that exits the catch tank as vapor through the vent line. The rate of polymer accumulation is substantial for the remaining 30 minutes.

The extension of startup time to 50 minutes actually increased approximately threefold the amount of polymer deposited in the polymer catch tank during startup. Correspondingly, it decreased the capability of the vessel to hold material that might arrive if there were problems with the extruder, thus increasing the possibility of overfilling.

The Augusta facility had a management system for evaluating the safety consequences of process changes, referred to as the “process change request procedure” (PCR). It was applied to hardware changes but not necessarily to modifications to operating procedures and practices. Chemical Process Safety: Learning From Case Histories states the following about process change:

---

## 4.3 Management of Change

---

**The extension of startup time to 50 minutes actually increased approximately threefold the amount of polymer deposited in the polymer catch tank during startup.**

---

---

A change requiring a process safety risk analysis before implementing is any change (except 'replacement in kind') of process chemicals, technology, equipment and procedures. The risk analysis must ensure that the technical basis of the change and the impact of the change on safety and health are addressed (Sanders, 1999; p. 223).

No management of change (MOC) documents were available for the procedural change that extended the startup time of the polymer catch tank from 30 to 50 minutes.

---

## 4.4 Process Hazard Analysis

---

The polymer catch tank and the reactor knockout pot were the only possible destinations to which the flow could be diverted. However, the HAZOP team did not consider this situation as a possible cause of excess polymer accumulation and level in either vessel.

---

During design in 1990 and again in 1999, after several years of operating experience, Amoco conducted process hazard analyses<sup>25</sup> of the Amodel process using the hazard and operability (HAZOP)<sup>26</sup> technique. Both the polymer catch tank and the reactor knockout pot were considered during the analyses, but credible scenarios that could lead to excess pressure or level were not identified.

In the 1990 HAZOP, the team identified failure of the extruder drive as a condition that could create a "no flow" situation, in which case it was recommended that the polymer flow be stopped. The polymer catch tank and the reactor knockout pot were the only possible destinations to which the flow could be diverted. However, the HAZOP team did not consider this situation as a possible cause of excess polymer accumulation and level in either vessel.

The 1990 HAZOP study did not completely evaluate the extruder. The team noted that insufficient design information was available to conduct a full analysis and recommended a followup HAZOP of the extruder once the engineering drawings were finalized. This analysis was never conducted.

---

<sup>25</sup> Process hazard analysis (PHA) is a structured examination of a chemical process to identify factors that have the potential to create hazards; to uncover credible sequences of events (scenarios) that could result in undesired consequences; to evaluate the consequences of these scenarios should they occur; and to propose improvements, as warranted, to equipment, procedures, and management systems that reduce or eliminate the hazards, prevent the scenarios from occurring, or mitigate their consequences.

<sup>26</sup> HAZOP makes use of guidewords to help identify deviations from normal, intended operation that could result in potential hazards or operating problems.

---

In a 1993 incident, the polymer catch tank was overfilled when the extruder malfunctioned. Polymer was carried into the vent line and solidified, and the line had to be cut. Nevertheless, the 1999 HAZOP still failed to identify the means by which an excess level could occur in the vessel.

Overfilling contributed to the March 13, 2001, incident because it was partly responsible for plugging of the vent and relief piping—which confined the mass of plastic in the polymer catch tank. If the HAZOP studies had identified credible scenarios involving vessel overfilling and overpressurization due to extruder malfunctions, additional safeguards could have been recommended to reduce the probability or severity of the hazards. If overfilling had been effectively controlled, the sequence of events that led to the March 13 incident would have been less likely—even without knowledge of the decomposition hazard.

During the 1990 HAZOP, the team recognized that high pressure could occur in the reactor knockout pot if the emergency pressure relief system discharge line was plugged with solidified polymer. A recommendation was made to provide a system to ensure that the line was clear during operation, but no such system was established.

In the 1999 HAZOP, the team determined that the emergency pressure relief system was an adequate safeguard in the event of plugging of the normal vent. They did not recognize the credible scenario that both the normal and emergency vents could simultaneously plug with polymer, as occurred on March 13.

The 1990 HAZOP team recognized the possibility that personnel could be injured when opening the polymer catch tank cover if pressure had accumulated. A pressure gauge was installed on the vent line to address this concern, as recommended. However, neither the 1990 nor the 1999 HAZOP studies identified the possibility that polymer plugging in the line could render the gauge useless.

The potential hazards associated with startup and shutdown operations were not addressed because this was not a requirement of the HAZOP protocols.

---

**. . . the HAZOP documentation discusses no reactivity issues related to the polymer catch tank or the reactor knockout pot.**

---

---

Neither analysis documented any concerns with reactivity of material in the vessels.<sup>27</sup> The 1990 study made no reference to chemical reactivity. Although the 1999 study included the guidewords “properties of chemicals”—which may have been intended to encompass reactivity—the HAZOP documentation discusses no reactivity issues related to the polymer catch tank or the reactor knockout pot.

---

## 4.5 Design Deficiencies

---

**Prior to startup of the Amodel unit, Amoco had no experience in full-scale production of nylon plastics.**

---

---

**Although several alternative configurations were studied and tested, no reliable method was identified to indicate the level of polymer in the catch tank.**

---

Prior to startup of the Amodel unit, Amoco had no experience in full-scale production of nylon plastics. The design for the commercial manufacturing facility was based on several years of experience in pilot-plant and semiworks operations. Problems with the polymer catch tank became evident as full-scale operating experience accrued.

The polymer catch tank level indicating instrument was unreliable and prone to false indications. Additionally, it often broke when waste plastic was removed from the vessel, and frequently it was not replaced before restart. Although several alternative configurations were studied and tested, no reliable method was identified to indicate the level of polymer in the catch tank.

There were several instances when either the polymer catch tank or the reactor knockout pot was completely filled. This occurred as early as 1993; during each occurrence, polymer was carried into the vent system. Because the plastic tends to rapidly solidify upon cooling, overfilling could render inoperative both the vent piping and the emergency pressure relief devices—a potentially hazardous situation because the upstream process is capable of applying pressure far higher than the vessels’ maximum allowable working pressure. Operations management recognized that the catch tank was too small as early as 1993, but did not recognize all the consequences of overfilling.

---

<sup>27</sup> Although HAZOP can be a useful aid in recognizing hazards, it is not a primary mechanism to identify hazardous chemical properties. It is not a substitute for chemical testing. PHA is only one component of effective reactive chemical hazard management.

---

Spring-operated pressure relief valves on the polymer catch tank and the reactor knockout pot were intended to protect the vessels from overpressure. However, neither relief valve was shielded from the process fluid by a rupture disk<sup>28</sup> upstream of the inlet. It is typical engineering practice to provide such protection where the process fluid may solidify and foul the valve inlet. Rupture disks were used to protect relief valves on other upstream equipment.

The IChemE Relief Systems Handbook discusses the need for protecting pressure relief valves with rupture disks. It states:

... the objective here is to protect the safety valve against conditions in the pressurized system which may be corrosive, fouling or arduous in some other way (Parry, 1998; p. 30).

Maintenance records show that the relief valve on the polymer catch tank was machined and repaired in June 1993 because of polymer fouling. The valve was put back in service, but it required repair again just 2 months later. Similar damage occurred in 1995. The valve was reconditioned more often than any other relief valve in the Amodel unit. The relief valve for the reactor knockout pot was reconditioned twice in the same period.

Despite this damage history, neither valve had been shop inspected from 1995 until the time of the incident. Problems with the relief system were symptomatic of design deficiencies with the polymer catch tank; however, there is no conclusive evidence that inadequate pressure relief capability directly contributed to the March 13 incident.<sup>29</sup>

Double block and bleed valves<sup>30</sup> on the inlet line and vent line of the polymer catch tank were intended to provide secure isolation of the vessel from the operating process during maintenance. Each of the

---

**Because the plastic tends to rapidly solidify upon cooling, overfilling could render inoperative both the vent piping and the emergency pressure relief devices . . .**

---

---

<sup>28</sup> A rupture disk is a thin disk composed of metal or composite material that is designed to break at a predetermined pressure.

<sup>29</sup> As discussed in Appendix A, there is considerable uncertainty as to the pressure inside the polymer catch tank at the time of failure; it is not known whether it exceeded the vessel's maximum allowable working pressure.

<sup>30</sup> Double block and bleed refers to an arrangement where two inline valves are placed in series with a drain valve between them. To provide isolation, the two inline valves are closed and the drain is opened. Leakage across the first inline valve is apparent as flow through the drain.

---

. . . plastic inside the catch tank sometimes obstructed nozzles leading to the ram-type valves, which were intended to positively verify that the vessel was depressurized and safe to open.

---

vessel end covers was equipped with a ram-type<sup>31</sup> valve for use as a drain or vent. However, soon after the Augusta plant was commissioned, it became apparent that the double block valves were ineffective. Solidified plastic seized the internal mechanisms, and the valves would not close. Similarly, plastic inside the catch tank sometimes obstructed nozzles leading to the ram-type valves, which were intended to positively verify that the vessel was depressurized and safe to open. On the day of the incident, solid polymer had accumulated in the nozzles leading to the drain valves, which likely rendered them inoperative.

Waste plastic tenaciously adhered to the inside of the polymer catch tank. It was typical practice to attach a cable to the metal frame in the vessel and use a forklift to pull and extract the plastic. Augusta operations management had expressed concern about possible occupational injuries to maintenance workers during this manual cleaning operation.

Because of these problems, operations management considered various alternative designs for the polymer catch tank. It was not until late 2000 that an engineering request for a complete redesign was submitted.

Each problem noted above warranted a reconsideration of the hazards of the waste handling system by Augusta facility management and, in some cases, implementation of incremental engineering or procedural safeguards. In total, these deficiencies were indications that the system design was flawed; a fundamental re-evaluation was needed to effectively correct the deficiencies.

---

<sup>31</sup> A ram-type valve is designed to resist plugging.

---

## 4.6 Procedures for Safe Opening of Process Equipment

---

The Augusta site policy for control of hazardous energy and lockout/tagout required specific written procedures for preparing individual pieces of process equipment for opening. Although a written guideline existed for the polymer catch tank, it could not be followed because it called for the use of drain valves, which had proven to be ineffective. Consequently, the guideline was not used, and there was no standard practice among the workforce for ensuring that the vessel was depressurized prior to opening.

One maintenance technician told investigators that it was his practice to open one of the drain valves and check whether vacuum applied to the polymer catch tank vent line drew in ambient air. If it did, he inferred that the vessel was partly clear inside, depressurized, and safe to open. Other employees stated that they did not use the drain valves because of plugging.

Investigators examined previously completed equipment isolation lists and confirmed that drain valves were seldom used to verify that the polymer catch tank was depressurized. Some personnel asserted that they relied on the pressure gauge on the vent line to check for pressure in the vessel, which was its intended use.

The Augusta facility policy for control of hazardous energy and lockout/tagout required the completion of a “try step,”<sup>32</sup> which was intended to verify the effectiveness of equipment de-energization. For the polymer catch tank, the logical means of conducting the try step was to open a drain valve on the vessel to observe the absence of gas, liquid, or pressure.

There were no initials under the try step on the equipment isolation list issued on the day of the incident, and it is not known whether the drain valves were used. However, it is unlikely because they were found in the closed position after the incident.

Investigators believe that, on March 13, workers most likely relied on knowledge that the process was shut down—and possibly on a reading from the pressure gauge on the plugged vent line—to conclude that there was no pressure in the polymer catch tank. No positive verification occurred.

---

**. . . there was no standard practice among the workforce for ensuring that the vessel was depressurized prior to opening.**

---

---

**. . . workers most likely relied on knowledge that the process was shut down—and possibly on a reading from the pressure gauge on the plugged vent line—to conclude that there was no pressure in the polymer catch tank. No positive verification occurred.**

---

---

<sup>32</sup> The try step is a positive means of verifying that equipment is de-energized. It might include pushing the start button on a machine to confirm that it does not start or—for process equipment—opening a vent or drain to ensure that there is no pressure.

---

The control of hazardous energy policy for the Augusta site did not advise the workforce when to suspend activities if problems occurred and safe equipment opening precautions could not be met.

---

A petrochemical industry consensus standard, *The Safe Isolation of Plants and Equipment*, warns about the potential hazard of reliance on pressure gauges:

Pressure gauges are reliable indicators of the existence of pressure but not of complete depressurization. Final confirmation of zero pressure before opening must always be by checking [an] open vent (HSE, 1997; p. 27).

The control of hazardous energy policy for the Augusta site did not advise the workforce when to suspend activities if problems occurred and safe equipment opening precautions could not be met. In such circumstances, stop work provisions—which trigger higher level management review and authorization of alternate work procedures—can increase safety.

For example, failure to obtain a positive result during the try step might trigger a stop work provision. Had such a policy been in force, the procedure for isolating and verifying de-energization of the polymer catch tank may have been reviewed by management years before the incident, when problems with plugging of the valves first became apparent. This review might have led to redesign of the equipment.

---

## 4.7 Incident and Near-Miss Investigations

---

By one estimate, 500 pods were made during the first night of startup; the next morning the pods began to explode.

---

The commercial Amodel unit experienced polymer reaction incidents dating from its initial startup in late 1993. These incidents presented the opportunity to recognize a reactive hazard that was not identified during process design.

---

### 4.7.1 Exploding Polymer Pods

---

During initial startup of the commercial unit, the startup team ran the reaction system and extruder for an extended time while the pelletizing system was inoperative. Polymer from the extruder discharge was diverted from the pelletizer and manually collected in wheelbarrows. It was then cooled by water spray, which caused it to harden on the outside. The results were “pods” of polymer roughly the shape of the wheelbarrow, which were dumped and left to cool for later disposal. By one estimate, 500 pods were made during the first night of startup;



---

the next morning the pods began to explode. Large pieces of the hardened outer shells blew off and traveled 30 feet or more. One fragment weighed 9 pounds.

The pods were formed from molten material with an initial temperature of approximately 315°C. Because solid Amodel is a good thermal insulator, the inner core of a pod is increasingly shielded from heat losses as the outer shell cools, hardens, and thickens. Witnesses described the exploded pods as having molten cores.

A company investigation concluded that the pods exploded because uneven cooling resulted in large stresses in the hardened outer shells, which led to fracturing and ejection of fragments. To correct this problem, Amoco installed a system to parcel the waste into smaller pieces and quickly cool it when the polymer could not be extruded through the pelletizing die.

Fewer pods were made during subsequent startups, and they were taken to a more remote area to cool. These actions—combined with other operational changes—significantly reduced the occurrence of exploding pods.

As described in Appendix A, further reactions and decomposition may occur if nylon plastics are held at elevated temperatures in a molten state. Such situations can produce water vapor and gases, which—if confined—create pressure.<sup>33</sup> Witnesses described the molten cores of exploded pods as discolored, which is consistent with decomposition. Pod explosions were partly caused by internal pressurization due to gas-forming decomposition reactions. Company investigations did not recognize this element of causation.

---

**Because solid Amodel is a good thermal insulator, the inner core of a pod is increasingly shielded from heat losses as the outer shell cools, hardens, and thickens. . . . Pod explosions were partly caused by internal pressurization due to gas-forming decomposition reactions.**

---

---

## 4.7.2 Waste Polymer Fires

Prior to the March 13 incident, there were also numerous fires involving the extruder and its associated equipment. CSB investigators reviewed 21 near-miss incident reports since 1997 in which the description of fire

---

<sup>33</sup> The saturation pressure of steam (produced by side reactions of the polymer) at 315°C is about 1,500 pounds per square inch gage (psig). Decomposition would form other gases, further increasing the potential for high pressure.

---

None of the investigations into these four ignition incidents recognized that they may have been caused by decomposition of the plastic and subsequent formation of volatile and flammable substances.

---

---

Beyond the near-miss reporting system, the Augusta site had no system in place to collectively analyze incidents for recurring problems and identify issues for additional study.

---

was consistent with chemical decomposition of polymer in the extruder. Most fires were small and caused little or no damage; they typically occurred when air was introduced into the equipment. However, in July 2000, a fire inside the extruder was severe enough to turn the extruder vent system ducting “cherry red” and to ignite external insulation. Although each incident was reported and documented, none were adequately investigated to determine the cause/source of flammable or combustible materials. Product decomposition was not identified as a contributing factor.

In August 2000, a fire occurred when the extruder was being purged with a polyethylene-based cleaning material. As a result of the incident investigation, an action was identified to take necessary measures to eliminate fires from the extruder. Although a different type of cleaning material was selected, fires continued to occur. No subsequent actions were taken.

On March 12, 2001, a similar fire involving purge material caused the extruder system to malfunction, which led to the aborted startup. The fire was extinguished, but no incident report was filed.

In addition, spontaneous fires occurred on two occasions when the polymer catch tank and the reactor knockout pot were opened. On two other occasions, waste polymer extracted from these vessels spontaneously caught fire after being disposed of in a dumpster. Investigations incorrectly attributed the dumpster fires to spontaneous combustion of extraneous materials. None of the investigations into these four ignition incidents recognized that they may have been caused by decomposition of the plastic and subsequent formation of volatile and flammable substances.

---

### 4.7.3 Inadequate Review of Cumulative Incidents

These incidents are evidence of a pattern of near-miss events in which hazards were not successfully identified and recurring issues were not adequately resolved. Beyond the near-miss reporting system, the Augusta site had no system in place to collectively analyze incidents for recurring problems and identify issues for additional study.

---

The reactive hazards of large masses of Amodel could have been identified if the company had recognized recurring patterns among incidents and more intensively investigated the causes of exploding pods and waste polymer fires. Detailed investigations would likely have led to recognition that a significant hazard was associated with accumulating large quantities of molten polymer. Other points at which molten polymer accumulated in the Amodel process could have been identified as having a similar hazard. The polymer catch tank and the reactor knockout pot were the most obvious of these possibilities.

---

## 4.8 Review of Similar Incident

CSB investigated a similar incident at the Equilon Enterprises oil refinery delayed coking unit<sup>34</sup> in Anacortes, Washington (CSB, 2001). On November 25, 1998, hot petroleum liquid and vapor rapidly discharged from the bottom head of a coke drum when it was opened. Six persons working close to the drum were fatally injured in the ensuing fire.

A loss of electric power and steam supply prior to the fire had resulted in abnormal process conditions, which interrupted completion of the normal cooling cycle required to produce a batch of coke. A buildup of tarry oil in piping prevented the injection of steam and water to cool the contents of the coke drum, and it was necessary to empty the partially filled drum.

The process supervisor and crew assumed that the contents had cooled to safe levels during the 2 days since the power failure. In addition, the relatively cool temperature of the bottom flange erroneously suggested that the temperature inside the drum was cool when only the material adjacent to the inside walls had actually cooled.

Although unknown to the workers present, the core material in the drum was insulated from heat loss. Within the core, residual heat

---

<sup>34</sup> A delayed coking unit converts heavy tar-like oil to lighter petroleum products, such as gasoline and fuel oil. Petroleum coke is a byproduct of the process. Petroleum coke is produced in batches contained in large drums. A full coke drum contains a tarry mass, which solidifies to a coal-like substance (coke) when cooled by the addition of steam and water. The top and bottom of the drum are opened at the completion of the cooling cycle, and the solid mass of coke is cut into pieces and removed from the vessel.

---

In both incidents, unanticipated reactions in a vessel created gas and pressure. A layer of material near the vessel surface provided an insulating effect and pressure-containing boundary.

---

---

Although endothermic reactions absorb energy, they can proceed as long as a reservoir of heat is available to sustain the reaction. If the temperature is sufficiently high, the energy in the materials themselves serves as a reservoir.

---

allowed petroleum to continue to react and break down, creating a pocket of hot, pressurized hydrocarbons. When the drum was opened, the hydrocarbons rushed out and formed a flammable vapor cloud that subsequently ignited.

The BP Amoco and Equilon incidents are similar because each involved:

- Opening of equipment when there were false indications or misunderstandings of temperature and pressure in the vessel core.
- Endothermic decomposition reactions that produced gaseous byproducts.
- Hazards created by abnormal startup or shutdown operations.
- Manual opening of hot, pressurized equipment.

In both incidents, unanticipated reactions in a vessel created gas and pressure. A layer of material near the vessel surface provided an insulating effect and pressure-containing boundary. Both process instrumentation and opening practices failed to provide adequate warnings of the state of the material inside.

The hazards of exothermic reactions—such as rapid energy release due to self propagation—are extensively documented in the literature; there is less documentation on the hazards of endothermic reactions. Although endothermic reactions absorb energy, they can proceed as long as a reservoir of heat is available to sustain the reaction. If the temperature is sufficiently high, the energy in the materials themselves serves as a reservoir.

In these two incidents, the reaction rate was probably slow; however, endothermic reactions can also proceed at high rates. Furthermore, they may pose other hazards such as gas production or the formation of toxic substances.

Following each incident, the process was redesigned so that personnel did not have to directly open the equipment. For the coke drums, a new remotely controlled station allowed workers to place themselves farther from the drum while the head was being lowered. The Amodel process was redesigned to eliminate large accumulations of molten plastic.

---

## 5.0 Regulatory Analysis

---

### 5.1 Process Safety Management

The Occupational Safety and Health Administration (OSHA) has issued a process safety management (PSM) standard intended to prevent or minimize the consequences of catastrophic releases of toxic, reactive, flammable, or explosive chemicals.<sup>35</sup> The standard applies to processes<sup>36</sup> containing more than a threshold quantity of any one of 137 OSHA-listed “highly hazardous chemicals.” Substances are listed based on their toxic or reactive properties. Flammable substances are also covered as a class.

Certain manufacturing processes at the Augusta facility are required to comply with the OSHA PSM standard because they meet the criteria noted above. However, the Amodel process does not contain any of the listed chemicals, nor does it contain substances that meet the flammability criteria. It is not subject to the standard.

To implement OSHA requirements, BP Amoco developed a PSM program based on the 14 safety management elements of the OSHA standard. The site PSM plan specified that the program be applied to processes covered by the OSHA standard. However, BP Amoco voluntarily applied much of the program to the Amodel process as well.

For example, the company had compiled process safety information, conducted PHAs, developed standard operating procedures, conducted training, applied MOC policies, and investigated incidents. Interviews with Augusta facility personnel indicated that—though most of the PSM program elements were implemented in the Amodel process—some were applied less rigorously than others.

With regard to the Amodel process, CSB has identified the following weaknesses in BP Amoco’s PSM program implementation as having some causal relationship to the incident:

---

<sup>35</sup> 29 CFR 1910.119, Process Safety Management of Highly Hazardous Chemicals.

<sup>36</sup> OSHA defines a process as any activity involving a highly hazardous chemical, including any use, storage, manufacturing, handling, or onsite movement of such chemicals, or any combination of these activities. For purposes of this definition, any group of vessels that is interconnected and separate vessels that are located such that a highly hazardous chemical could be involved in a potential release are considered to be a single process.

---

The procedure for preparing to open the polymer catch tank became invalid after it was discovered that the isolation and drain valves were ineffective.

---

---

One of the elements of the OSHA PSM standard requires the compilation of thermal stability data for process chemicals.

---

- The program required that a PHA be completed prior to initial startup of a manufacturing process. However, because the extruder was not included in the PHA before startup of the Amodel process, some extruder malfunctions were not identified as potential causes of overfilling the polymer catch tank (see Section 4.4).
- The program called for an MOC review of safety consequences before changes were made to key operating procedures. No MOC review was conducted when the Amodel process startup time was changed from 30 to 50 minutes. The implications of this change were not fully identified (see Section 4.3).
- The procedure for preparing to open the polymer catch tank became invalid after it was discovered that the isolation and drain valves were ineffective. The site PSM program required regular revalidation of operating procedures. Had this requirement been more rigorously applied, the need to make design changes to the polymer catch tank may have been identified earlier.
- One of the elements of the OSHA PSM standard<sup>37</sup> requires the compilation of thermal stability data for process chemicals. Although the BP Amoco R&D department developed some thermal stability data for Amodel because of concerns for product quality, the results of this work were not recognized as applicable to process safety.

---

<sup>37</sup> 29 CFR 1910.119, (d) (1) (vi).

---

## 5.2 Lockout/Tagout

OSHA has also established a standard on controlling hazardous energy (lockout/tagout).<sup>38</sup> Its purpose is to prevent unexpected energization, startup, or release of stored energy when personnel interact with machinery or equipment. The standard requires employers to establish an energy control program and follow procedures to apply lockout/tagout<sup>39</sup> devices or energy isolation devices, or to otherwise disable such equipment.

The Augusta facility had a policy in place to comply with OSHA lockout/tagout requirements. However, opening the polymer catch tank while it was pressurized represented a failure to control hazardous energy.

---

**. . . opening the polymer catch tank while it was pressurized represented a failure to control hazardous energy.**

---

---

<sup>38</sup> 29 CFR 1910.147, The Control of Hazardous Energy (lockout/tagout).

<sup>39</sup> OSHA defines “lockout” as the placement of a lockout device on an energy isolating device, in accordance with an established procedure, to ensure that the energy isolating device and the equipment being controlled cannot be operated until the lockout device is removed. OSHA defines “tagout” as the placement of a tagout device on an energy isolating device, in accordance with an established procedure, to indicate that the energy isolating device and the equipment being controlled cannot be operated until the tagout device is removed (29 CFR 1910.147(b)).





---

# 6.0 Root and Contributing Causes

---

## 6.1 Root Causes

1. **Amoco, the developer of the Amodel process, did not adequately review the conceptual process design to identify chemical reaction hazards.**

Neither Amoco's R&D department nor the process design department had a systematic procedure specifically for identifying and controlling hazards from unintended or uncontrolled chemical reactions.

2. **The Augusta facility did not have an adequate review process for correcting design deficiencies.**

The Augusta site was the first and only commercial manufacturing facility for Amodel. Several problems in design of the polymer catch tank became apparent with operating experience. Operations management did not ensure that deficiencies were corrected in a timely manner.

- Workers were unable to follow established company policies for lockout/tagout and equipment opening because the plugged drains on the polymer catch tank prevented them from verifying the absence of pressure in the tank.
- Previous occurrences of overfilling and plastic entrainment into connected piping indicated that the polymer catch tank was too small to handle foreseeable process upsets.
- The level indicating device for the polymer catch tank was unreliable.

3. **The Augusta site system for investigating incidents and near-miss incidents did not adequately identify causes or related hazards. This information was needed to correct the design and operating deficiencies that led to the recurrence of incidents.**

- Sound technical theories were not developed to explain the spontaneous ignition of waste plastic or the phenomenon whereby lumps of waste plastic burst.
- Incidents and near misses tended to be treated as isolated events. Management did not have a review system to detect trends and patterns among incidents.

- 
- The polymer catch tank had been overfilled and the vent lines plugged on other occasions. No effective measures were developed to prevent recurrence.
  - Fires had occurred at the extruder on numerous occasions. No effective countermeasures were developed.

---

## 6.2 Contributing Causes

1. **Hazard analyses of the Amodel process were inadequate and incomplete.**
  - Reactivity hazards, such as unintended reactions, were not examined in the final design-phase hazard analysis.
  - The extruder operation and its overall impact on the rest of the process were not adequately reviewed during the formal hazard analysis conducted during design and construction.
  - Credible scenarios by which the polymer catch tank could become overfilled were not identified.
2. **Design documentation did not adequately describe the Amodel process.**
  - The process description did not adequately explain the design basis and operating principles for the polymer catch tank; as a result, misunderstandings of these characteristics developed. The maximum fill level was not clearly specified. No warnings were provided about the consequences of overfilling.
  - Operations management did not update the documentation to reflect changes in procedures and practices.
3. **Equipment opening procedures did not specify what actions to take when safety precautions could not be met.**

On the day of the incident and frequently during the life of the Amodel process, it was not possible to verify the absence of pressure in the polymer catch tank, as required by company procedures and OSHA lockout/tagout regulations. Solid polymer

---

plugged the drain nozzles, which should have been used to verify the absence of pressure. Without a policy requiring management review and authorization in such circumstances, workers proceeded to open the vessel despite the lack of positive verification that it was not pressurized.

**4. Revisions to operating procedures were not subjected to management of change reviews to evaluate safety effects.**

Flow was originally directed to the polymer catch tank for 30 minutes during startup. Without adequate consideration of possible adverse consequences, this time was later extended to 50 minutes—which increased the amount of material to be disposed of to the vessel.



---

## 7.0 Recommendations

---

Solvay Advanced  
Polymers, L.L.C.

1. Examine the manufacturing businesses acquired from BP Amoco Performance Polymers and ensure that a systematic safety review procedure is developed and implemented for identifying and controlling hazards from unintended chemical reactions. Additionally, ensure that reactive hazards are identified and evaluated:
  - During product R&D, during conceptual design of a new process, and during detailed design of a new process.
  - Before changes are made to existing equipment or process chemistry.

Communicate the results of this review to the workforce.  
(2001-03-I-GA-R1)

2. Ensure that a program is in place at facilities acquired from BP Amoco Performance Polymers to systematically review the hazards associated with new and modified processes and equipment as operating experience accrues. Ensure that facilities correct all identified design, operation, and maintenance deficiencies. Verify that operating experience does not invalidate the design basis for equipment. (2001-03-I-GA-R2)
3. Revise the Material Safety Data Sheet (MSDS) for Amodel to warn of the hazards of accumulating large masses of molten polymer. Communicate the MSDS changes to current and past customers (who may retain inventories of this product). (2001-03-I-GA-R3)

---

Solvay Advanced  
Polymers, L.L.C.,  
Augusta Facility

1. Implement a program to conduct periodic management reviews of incidents and near-miss incidents. Look for trends and patterns among incidents. Address root causes and implement and track corrective measures. (2001-03-I-GA-R4)
2. Revise process safety information to include (2001-03-I-GA-R5):
  - Information regarding the decomposition reactions of Amodel.
  - Design intent, basis, capacity, and limitations of equipment.
  - Hazards and consequences of deviations from design intent and operating limits.
3. Revalidate hazard analyses for the Amodel process to address (2001-03-I-GA-R6):
  - Credible deviations from process intent and their consequences.
  - Hazards associated with startup and shutdown operations.
  - Prevention of accumulations of potentially hazardous masses of polymer.
4. Revise your lockout/tagout program to ensure that equipment is rendered safe prior to opening for maintenance. At a minimum, ensure that equipment opening procedures contain a stop work provision that requires higher levels of management review and approval when safe opening conditions, such as equipment depressurization, cannot be verified. (2001-03-I-GA-R7)
5. Ensure that your management of change policy applies to operational and procedural modifications. (2001-03-I-GA-R8)

---

BP Chemicals Group

Communicate the findings of this report to your chemical and plastics manufacturing facilities in North America. (2001-03-I-GA-R9)

---

Communicate the findings of this report to your membership.  
(2001-03-1-GA-R10)

American Chemistry  
Council

---

Communicate the findings of this report to your membership.  
(2001-03-1-GA-R11)

Society of  
Plastics Engineers

---

By the

**U.S. CHEMICAL SAFETY AND HAZARD INVESTIGATION BOARD**

Gerald V. Poje, Ph.D.

Member

Isadore Rosenthal, Ph.D.

Member

Andrea Kidd Taylor, Dr. P.H.

Member

May 20, 2002





---

## 8.0 References

---

- Ballistreri, A., D. Garozzo, M. Giuffrida, and G. Montaudo, 1987. "Mechanism of Thermal Decomposition of Nylon 66," *Macromolecules*, Vol. 20, pp. 2991-2997.
- Ballistreri, A., D. Garozzo, P. Maravigna, M. Giuffrida, and G. Montaudo, 1987. "Thermal Decomposition Processes in Aromatic-Aliphatic Polyamides Investigated by Mass Spectrometry," *Journal of Polymer Science, Part A: Polymer Chemistry*, Vol. 25, pp. 1049-1063.
- Barton, John, and Richard Rogers, 1997. *Chemical Reaction Hazards, A Guide to Safety*, Rugby, U.K.: Institution of Chemical Engineers (IChemE).
- Center for Chemical Process Safety (CCPS), 1995a. *Guidelines for Chemical Reactivity Evaluation and Application to Process Design*, American Institute of Chemical Engineers (AIChE).
- CCPS, 1995b. *Guidelines for Safe Storage and Handling of Reactive Materials*, AIChE.
- CCPS, 1989. *Technical Management of Chemical Process Safety*, AIChE.
- Gander, Jesse D., and A. Jeffrey Giacomini, 1997. "Review of Die Lip Buildup in Plastics Extrusion," *Polymer Engineering & Science*, July 1997.
- Health and Safety Executive (HSE), 2000. *Designing and Operating Safe Chemical Reaction Processes*, Norwich, U.K.: HSE Books.
- HSE, 1997. *The Safe Isolation of Plants and Equipment*, Oil Industry Advisory Committee, Norwich, U.K.: HSE Books.
- Kamerbeek, B., G. H. Kroes, and W. Grolle, 1961. *Thermal Degradation of Polymers*, SCI Monograph No. 13, London, U.K., pp. 357-391.
- Kohan, Melvin, 1995. *Nylon Plastics Handbook*, Hanser Publishers.
- Kohan, Melvin, 1973. *Nylon Plastics*, Wiley Interscience.
- Ohtani, H., T. Nagaya, Y. Sugimura, and S. Tsuge, 1982. "Studies on Thermal Degradation of Aliphatic Polyamides by Pyrolysis-Glass Capillary Gas Chromatography," *Journal of Analytical and Applied Pyrolysis*, Vol. 4, pp. 117-131.

---

Parry, Cyril F., 1998. Relief Systems Handbook, Rugby, U.K.: IChemE.

Sanders, Roy F., 1999. Chemical Process Safety: Learning From Case Histories, Butterworth-Heinemann.

Schulten, H., and B. Plage, 1988. "Thermal Degradation of Aliphatic Polyamides Studied by Field Ionization and Field Desorption Mass Spectrometry," Journal of Polymer Science, Part A: Polymer Chemistry, Vol. 26, pp. 2381-2394.

U.S. Chemical Safety and Hazard Investigation Board (CSB), 2001. Safety Bulletin, Management of Change, No. 2001-04-SB, August 2001.

---

# APPENDIX A: Reconstruction of Incident

---

## A.1 Post-Incident Scene

---

### A.1.1 Suspension of Site Operations

Following the March 13, 2001, incident, BP Amoco shut down all manufacturing units at the Augusta site to review safety programs and conduct additional training. Operations were restored at one process unit on April 8 and at others on April 13. The Amodel unit did not restart until July 27, following the implementation of major design changes.

---

### A.1.2 Polymer Catch Tank

Most of the polymer catch tank contents was expelled, including the metal frame. A solid layer of polymer 3 to 5 inches thick, predominately yellow, remained in the vessel and coated the entire inside surface (see cover photo). Although the layer contained some bubbles and voids, it was composed of relatively dense material. Polymer was extruded into all the vessel nozzles, and they were completely plugged at the inlet (Figure A-1).

The upper portion of the flange, to which the polymer catch tank cover had been bolted, was bent. The thrust created by the sudden expulsion displaced the catch tank in an opposite direction. This movement bent the vessel inlet line and broke the hot oil tubing behind the vessel.

The cover was found 14 feet from the polymer catch tank. A girder for a canopy that sheltered the catch tank and extruder was torn from its structural members. The cover probably struck the girder as it blew off the tank.

Examination of the cover suggested that it was bent by the pressure that caused the bolts to break. Half of the 44 bolts were still in place at the time of failure; all were recovered (Figure A-2). Examination of the bolts revealed a combination of failure modes—ductile (i.e., thinning before breaking) and shear (i.e., rapid overload). None of the studs separated from the nuts. The drain valve attached to the cover was found in the closed position.

---

A solid layer of polymer 3 to 5 inches thick, predominately yellow, remained in the vessel and coated the entire inside surface.

---



Figure A-1. Polymer plugging the polymer catch tank vent nozzle.



Figure A-2. Failed bolts from polymer catch tank cover.

---

### A.1.3 Reactor Knockout Pot

The reactor knockout pot was not opened until April 17, 2001, to allow time for a hazard analysis and development of a safe work plan. Once opened, the vessel was found to be largely empty except for a 6-inch layer of material on the bottom (Figure A-3).

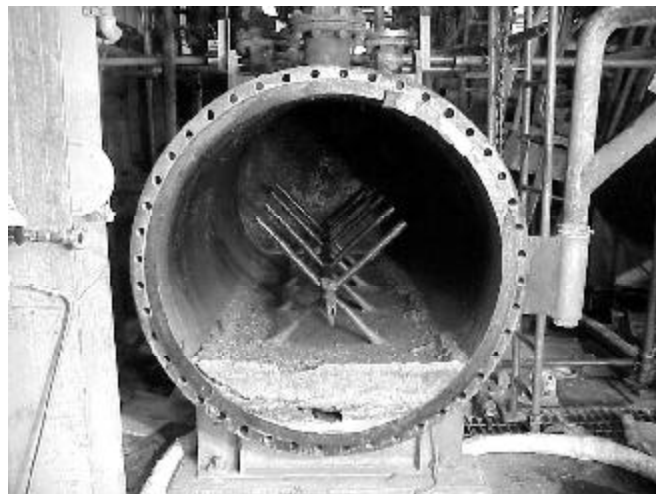

Figure A-3. Reactor knockout pot with internal frame visible.

---

## A.1.4 Vent Piping

The outlet nozzle for the 6-inch vent line on the polymer catch tank was plugged with solid polymer (Figure A-4). The vent line itself was plugged except for a small hole through the center of the obstruction. A total of 22 feet of 6-inch pipe was plugged with polymer, including the part of the line where the pressure gauge was installed. The plugging extended to the common portion of the vent line shared with the reactor knockout pot, as outlined in Figure 4 (Section 2.3). The polymer inside the pipe had an appearance characteristic of several annular layers, each distinct in color and separated by discontinuities (Figure A-4).

The tap<sup>1</sup> to the pressure gauge on the 6-inch vent line was observed to be clear despite extensive plugging of the line itself.



Figure A-4. Vent line obstructed by polymer layers.

---

## A.1.5 Pressure Relief System

The pressure relief valve and associated piping were removed for examination. The inlet line to the relief valve was plugged with polymer up to the device. The discharge line was clear beyond the relief valve. CSB concludes that it is unlikely that the pressure relief valve activated prior to the incident.

---

The polymer inside the pipe had an appearance characteristic of several annular layers, each distinct in color and separated by discontinuities.

---

---

## A.1.6 Extruder

The extruder was disassembled and inspected. The gearbox was found to be out of synchronization, and a bearing for one of the screws was cracked. The screws appeared to have collided with each other and were fouled by an ash-like material.

A maintenance technician had first noticed the ash at approximately 3:45 pm on March 12, during the aborted startup, while attempts were made to diagnose the extruder malfunction (see Sections 3.1.2 and 3.3.1). This was the first observation of ash on the screws; there was no explanation for it at the time.

---

The screws appeared to have collided with each other and were fouled by an ash-like material.

---

---

<sup>1</sup> A tap is a small-diameter branch pipe connected to a larger pipe.

---

### A.1.7 General Area

Expelled polymer was scattered northward throughout the area, up to 70 feet from the polymer catch tank (Figure A-5). Some of the polymer was charred by fire. Much of the area at grade was covered with a fine silica ash, which was determined to be a product of combustion of the heat transfer fluid that had fueled the fire.

---

Much of the area at grade was covered with a fine silica ash, which was determined to be a product of combustion of the heat transfer fluid that had fueled the fire.

---

Part of the metal rack expelled from the tank was found 40 feet from the vessel, imbedded into insulation on piping to a control valve station. The control valve and piping were displaced more than 6 inches in the direction of impact.



Figure A-5. Polymer scattered throughout work area.

---

## A.2 Extruder Failure

---

Inspection of the extruder barrels after the incident revealed a large amount of ash, which was very likely the result of a fire in the extruder. In the early morning of March 12—about 12 hours before the aborted startup attempt—the extruder temperature was raised to 315°C, and the machine was briefly prerun on a purging material. This activity was standard procedure; it was always done just before the reaction section of the plant was started up.

However, on this occasion, a mechanical problem in the reaction section delayed startup until the afternoon of March 12. Air had likely entered an open divert valve on one of the extruder barrels and flowed across the screws. Temperature-measuring instruments on the extruder recorded abnormally high values during this period; it is likely that the residual purge material inside the extruder had ignited.

The observation of higher-than-normal temperatures is consistent with a release of heat from combustion of the purge material. Gaseous byproducts would have escaped through vents on top of the extruder, leaving ash behind.

Because the extruder was not designed to convey powder, the accumulated ash probably caused the screws to bind when attempts were made to start the machine at 2:16 pm on March 12. Although the motor start push button was activated more than 30 times, interlocks caused the motor to repeatedly shut down. These multiple attempts to start the motor applied torque to the seized screws of the machine, which likely explains how the bearing became cracked and the gearbox unsynchronized.

Statements from several operators indicated that this was the first time the extruder failed to run coincidentally with startup of the reaction section. However, the machine or components were known to occasionally fail during routine operation. It was an extruder component failure during a production run that resulted in the plant shutdown on March 10. In early February 2001, a series of instrument failures on the extruder motor over 2 days culminated in shutdown of the process.

BP Amoco personnel were aware that various malfunctions could interrupt operation of the extruder during production. When the extruder experienced certain mechanical difficulties, it was necessary

---

**Temperature-measuring instruments on the extruder recorded abnormally high values during this period; it is likely that the residual purge material inside the extruder had ignited.**

---

---

**These multiple attempts to start the motor applied torque to the seized screws of the machine, which likely explains how the bearing became cracked and the gearbox unsynchronized.**

---

---

**. . . an extruder component failure during a production run . . . resulted in the plant shutdown on March 10. In early February 2001, a series of instrument failures on the extruder motor over 2 days culminated in shutdown of the process.**

---

---

to divert the reactor effluent and accumulate polymer in the polymer catch tank or the reactor knockout pot. On prior occasions, this had resulted in overflowing one of the vessels and plugging their common vent line.

---

## A.3 Polymer Catch Tank

---

**Because the process usually runs for an extended time, the prepolymer accumulated during startup has the opportunity to cool and solidify before the injection of additional hot material during shutdown and solvent flushing.**

---

---

### A.3.1 Thermal Considerations

During a typical startup, the amount of prepolymer sent to the polymer catch tank fills almost half the vessel. Because the process usually runs for an extended time, the prepolymer accumulated during startup has the opportunity to cool and solidify before the injection of additional hot material during shutdown and solvent flushing.

As a result of the aborted startup attempt on March 12, more than twice the normal mass of hot prepolymer was continuously directed to the polymer catch tank. This included prepolymer made during startup and extruder troubleshooting, plus hot material displaced from the reaction section of the plant during the solvent flush after the aborted startup. This much prepolymer had not been continuously fed to the catch tank on any previous occasions. The amount of thermal energy inside the vessel was probably greater than it had ever been before.

A model readily solidifies, becoming an effective insulator. Heat losses through the shell of the polymer catch tank ultimately resulted in the formation of a solid layer of plastic adjacent to the walls. Once formed, this layer created an insulating effect that allowed the core of material in the vessel to remain hot and molten for an extended time.



---

### A.3.2 Filling Beyond Working Capacity

CSB investigators determined that significant amounts of polymer had escaped into the vent system for the polymer catch tank and the reactor knockout pot—evidence that the catch tank was overloaded (i.e., run at conditions outside its design limit). Although the quantity of accumulated material is reasonably well known, the liquid level in the catch tank is unknown due to uncertainties with regard to density.<sup>2</sup>

Waste polymer cleaned from the catch tank on March 11, following the previous production run, was composed of multiple layers of varying density, with considerable voids between layers (Figure A-6). The waste polymer occupied 55 percent of the vessel and had a bulk density of only 3 lb/gal.



Figure A-6. Material extracted from polymer catch tank on March 11, prior to incident.

---

<sup>2</sup> BP Amoco plant engineering personnel estimated that the bulk density of material in the polymer catch tank ranged from 7 to 10 pounds per gallon (lb/gal), with the latter being the density of the final Amodel product. Material taken from the vessel post-incident had a measured bulk density varying from 5 to 7 lb/gal; however, this may not represent the density inside the vessel prior to the release of pressure.

---

As the polymer catch tank filled beyond its working capacity, its ability to separate vapor from molten prepolymer degraded.

---

---

The accumulated pressure eventually exceeded the sealing capability of the cover gasket, and solvent vapor leaked from the top of the . . . cover.

---

---

There was no direct indication of the level of material in the polymer catch tank because the level detection device was not installed.

---

---

The timer . . . did not account for prepolymer that entered during the solvent flush phase of the shutdown operation.

---

The reactor effluent enters the polymer catch tank as a two-phase mixture of polymer with a significant quantity of vapor. Vapor separates from the liquid inside the vessel, as depicted in Figure A-7. Additional vapor is generated when water and excess reactants evaporate from the melt.

As the polymer catch tank filled beyond its working capacity, its ability to separate vapor from molten prepolymer degraded. Polymer droplets were entrained with the vapor stream into the vent system (Figure A-8). Once inside the vent system, polymer deposited on the piping, hardened, and restricted the flow of vapor. This activity caused the catch tank to become pressurized.

The accumulated pressure eventually exceeded the sealing capability of the cover gasket, and solvent vapor leaked from the top of the 4-foot-diameter bolted cover. Upon discovery of the leak, the solvent flow was diverted from the polymer catch tank to the reactor knockout pot—which also began to leak because significant quantities of polymer had accumulated in the common vent piping, causing the pot to pressurize. Although the vent line was restricted, it did not completely plug off at this time; flow continued through the unit. Process pressures upstream were within normal operating ranges.

---

### A.3.3 Safeguards to Prevent Overfilling

There was no direct indication of the level of material in the polymer catch tank because the level detection device was not installed. A capacitance-type level probe had been used; however, it was unreliable because it was often fouled with polymer.

A timer mechanism was installed for the polymer catch tank in 1994 to indicate when accumulated prepolymer reduced the vessel's spare capacity to the extent that a production shutdown was required. The timer tracked the time that prepolymer entered the catch tank during startup or upset conditions, but it did not account for prepolymer that entered during the solvent flush phase of the shutdown operation.

The basis of the timer setting was to provide sufficient capacity in the polymer catch tank, plus an additional unspecified safety margin. There is no evidence to suggest that the timer mechanism took into account the

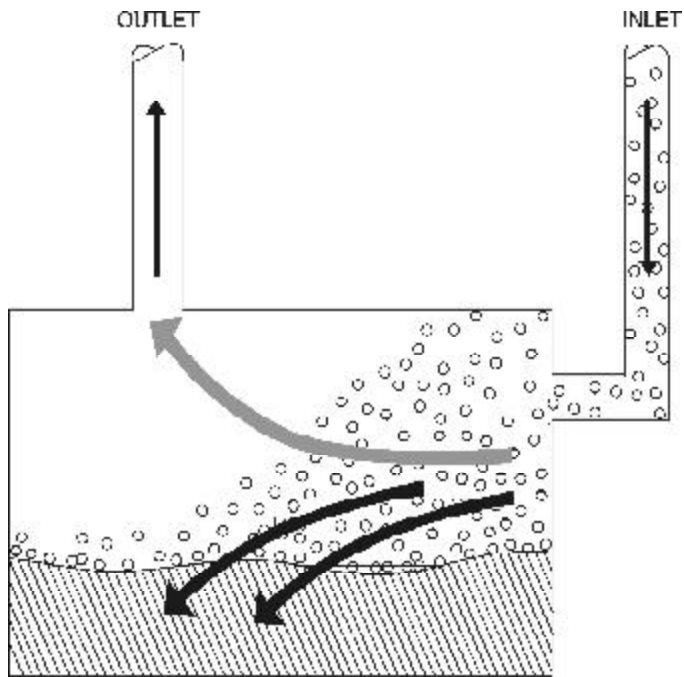

Figure A-7. Normal operation—settlement of particles.

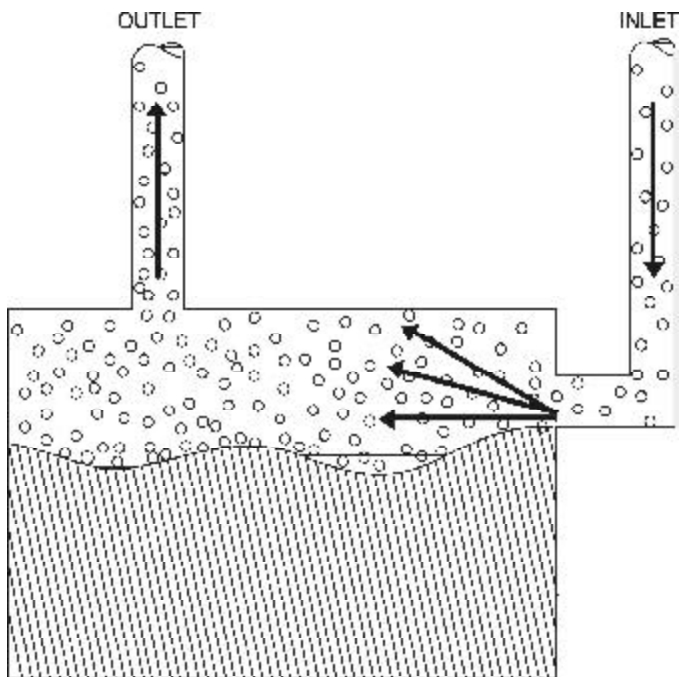

Figure A-8. Polymer catch tank filled beyond working capacity—particles entrained in vent vapor.

---

density variations of the material<sup>3</sup> or the added requirement for vapor-liquid disengagement. Considering these limitations—and the fact that it did not account for prepolymer that arrived during shutdown—the timer was an unreliable indicator of spare capacity in the vessel.

---

#### A.3.4 Analysis of Cover Bolts

The cover was attached to the polymer catch tank with 44 carbon steel grade SA-193 B16 bolts, each measuring 1 1/8 inches in diameter. The 22 bolts that failed were examined to determine the presence of damage or defects. Two of the intact bolts were analyzed by ASTM A370, Standard Test Methods and Definitions for Mechanical Testing of Steel Products, and found to be within specification for yield and tensile strength.

No brittle fracture characteristics were observed when the bolts were tested; they failed in a ductile mode. There was little variability among the specimens. From these test results, it was concluded that the bolts contained no prior defects—nor did they exhibit damage from fatigue, previous overloading, or environmental conditions.

---

No brittle fracture characteristics were observed when the bolts were tested; they failed in a ductile mode. . . . it was concluded that the bolts contained no prior defects—nor did they exhibit damage from fatigue, previous overloading, or environmental conditions.

---

---

#### A.3.5 Determination of Internal Pressure

The polymer catch tank had a maximum allowable working pressure of 108 pounds per square inch gage (psig). There was no direct indication of pressure in the tank at the time of the incident. Estimates were made of the force and pressure required to cause failure of the 22 cover bolts. However, this analysis was complicated by the fact that the restraining force applied by the remaining 22 bolts was not concentric to the cover; the bolts were removed in a sequential pattern from the 1:30 to 7:30 o'clock position.

---

<sup>3</sup> The timer algorithm was based on a polymer density of 10 lb/gal, which is equivalent to the finished polymer.

---

At the request of BP Amoco, M&M Engineering of Shaker Heights, Ohio, conducted a finite element analysis (FEA) to estimate pressure on the cover at the time of failure. A three-dimensional model was created for the shell of the polymer catch tank, mating flange, flange gasket, cover, and bolts. The static properties of the bolts were taken from the testing results described above, and the tensile properties were increased to account for dynamic effects (i.e., a rapid rate of bolt strain).

The results of the FEA indicate that the best estimate of the required pressure to fail the 22 remaining bolts is 50 psig (assuming static tensile properties) to 70 psig (assuming a 30 percent dynamic increase over static strength). Considering the uncertainties in dynamic loading of the bolts, 110 psig is provided as a conservative upper-bound estimate of failure pressure. This value corresponds to an assumed 100 percent increase in tensile properties due to dynamic effects. The analysis results indicate a significant decrease in the capability of the 22 remaining bolts due to the eccentric (i.e., not at or in the geometric center) nature of the restraining force.

The FEA did not attempt to account for the additional restraining force created by the 3- to 5-inch layer of hardened polymer that coated the inside wall of the polymer catch tank. Molded Amodel is a high-strength polymer with a tensile strength of 12,000 psig at ambient temperature. There is considerable uncertainty as to the strength of the polymer layer at the time of failure due to its differences in composition from neat Amodel and its elevated temperature.

Although the polymer coating is potentially capable of containing significant pressure beyond the 50- to 70-psig range estimated by FEA, any analysis of this additional pressure is highly speculative considering the aforementioned uncertainties. CSB concludes that the pressure inside the polymer catch tank at the time of failure was at least 50 psig.

---

**The analysis results indicate a significant decrease in the capability of the 22 remaining bolts due to the eccentric . . . nature of the restraining force.**

---

---

**There is considerable uncertainty as to the strength of the polymer layer at the time of failure due to its differences in composition from neat Amodel and its elevated temperature.**

---

---

## A.4 Physical Testing and Chemistry

---

---

... a source of pressure inside the polymer catch tank was gas formation due to thermal degradation.

---

---

Side reactions are another mechanism by which molten nylon polymers can generate gas.

---

---

### A.4.1 Potential Chemical Reactions

The public literature on nylon plastics describes them as susceptible to thermal degradation. The Nylon Plastics Handbook states that two general types of thermal reactions are expected (Kohan, 1995). One involves breakdown of the amide groups of the polymer; the other relates to instability inherent in the raw materials themselves. One example of the latter is the thermal breakdown of carboxylic acids to form gaseous carbon dioxide. A nylon polymer created from a di-carboxylic acid may be susceptible to this type of decomposition.

The literature describes other more complex possibilities for decomposition of the monomeric units of the polymer. These possibilities, among other evidence, led CSB investigators to theorize that a source of pressure inside the polymer catch tank was gas formation due to thermal degradation.

Side reactions are another mechanism by which molten nylon polymers can generate gas. Kohan (1995) describes how two amine ends from separate nylon polymer molecules can combine in a condensation reaction, producing a single molecule with a triamine group and releasing an ammonia molecule. The triamine entity of the newly formed molecule may, in turn, react by a second condensation with another polymer molecule that has a carboxylic acid end group, releasing a water molecule. When both of these reactions occur, polymer molecules become chemically linked through branches.<sup>4</sup>

One consequence of this phenomenon is referred to as “gelation.” The branched molecules have extremely high molecular weight and are referred to as gels. The BP Amoco documentation for the Amodel process includes a brief discussion of these potential branching reactions and states that limiting the time the reacting mix is subject to elevated temperatures will minimize their occurrence.

The Augusta site produces various grades of Amodel. A principal distinction among grades is how various di-carboxylic acids are apportioned among the ingredients. Amodel is made from isophthalic and

---

<sup>4</sup> The interconnection of polymer molecules through side branches is known as crosslinking.

---

adipic acids. At the time of the aborted startup, a grade with a lower percentage of aromatic acids was being produced. Fundamental principles of organic chemistry suggest that thermal stability should decrease with a reduction in aromatic acid content. This grade of Amodel had a relatively high melting point compared to other grades.

---

#### A.4.2 Characterization of Expelled Plastic

Investigators collected remnants of the plastic that was expelled from the polymer catch tank; the material was hard, brittle, and filled with bubbles (Figure A-9). However, the plastic was partially molten and sticky at the time it was expelled because some of it stuck to nearby pipes, steel columns, and the side of a storage shanty located almost 70 feet from the vessel.

Bubbles within the expelled material caused it to have a cellular structure. Consequently, the bulk density of the material was low compared to product samples of extruded Amodel. However, the plastic encasing the individual cells was dense. It had a specific gravity of 1.1, typical of normal extruded Amodel product. The presence of bubbles within the expelled material and its cellular structure are consistent with the generation and entrapment of gas while material is in a molten state. These characteristics support the theory that decomposition and side reactions—occurring while the material was molten inside the polymer catch tank—produced gas and pressure.

The expelled plastic was yellow, though typical extruded Amodel is cream colored. The discoloration is also consistent with exposure to high temperature for an extended time.

---

#### A.4.3 Characterization of Plastic Remaining in Vessel

A ring of plastic 3 to 5 inches thick remained inside the polymer catch tank after the molten core blew out (Figure A-10). The ring was generally yellow, though some of the outermost portions close to the vessel wall were cream colored. The plastic in the ring contained far



Figure A-9. Sample of material expelled from polymer catch tank (note bubbles and closed cells).

---

... the plastic was partially molten and sticky at the time it was expelled ...

---

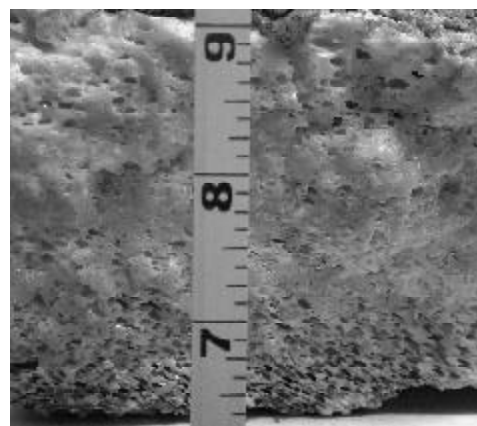

Figure A-10. Layer of hardened polymer taken from inside perimeter of polymer catch tank

---

The presence of bubbles within the expelled material and its cellular structure are consistent with the generation and entrapment of gas while material is in a molten state.

---

---

Because it was close to the vessel wall, [the cream-colored polymer] cooled sooner and was less susceptible to side reactions and thermal decomposition.

---

fewer bubbles than the expelled material. The concentration of bubbles was greatest farther from the vessel wall, toward the core.

Heat losses through the wall of the polymer catch tank from the time it was filled until it was opened likely explain why the material adjacent to the vessel wall solidified by the time workers started removing the cover. This explanation is also consistent with the observation that cream-colored polymer was prevalent along the outermost perimeter of the ring. Because it was close to the vessel wall, this material cooled sooner and was less susceptible to side reactions and thermal decomposition.

BP Amoco analysis of the plastic ring in the polymer catch tank showed the outer white material to be similar to typical Amodel, while the yellow material farther from the vessel wall contained gelled entities. It also had unusually high levels of triamine groups and atypically low levels of carboxylic acid groups. These differences indicate that the material farthest from the vessel wall had probably reacted by means of the branching side reactions described above. Such reactions generate gas, consistent with the observation that the maximum concentration of bubbles in the ring was farthest from the wall.

---

#### A.4.4 Simplified Thermal Testing

Following the incident, CSB arranged for testing of samples of typical extruded Amodel product pellets. Samples were sent to Polyhedron Laboratories, Inc., in Houston, Texas. Two grams of the cream-colored ~~pellets were dried and placed in the bottom of an autoclave,~~ which was evacuated to vacuum and then pressurized three times with 60-psig nitrogen. Finally, the material was heated to 315°C (the approximate condition in the molten core of the polymer catch tank) and held at that temperature for 12 hours. After cooling to room temperature, the autoclave was depressurized and opened. A solid brown residue was present on the bottom, and the entire inner surface of the autoclave was coated with a brown liquid. From the results of this experiment, CSB concludes that Amodel decomposes at the test temperature.

---

<sup>5</sup> An autoclave is an airtight vessel for heating and sometimes agitating its contents under high pressure.



---

Following this testing, a portion of the pellet sample was tested by thermogravimetry<sup>6</sup> at Chemir/Polytech Laboratories, in Maryland Heights, Missouri. The pellets were ground to a powder and vacuum dried at 100°C for 12 hours. Two conditions were chosen for testing—holding at 315°C for 2 hours and for 12 hours. The 2-hour test resulted in a weight loss of 2.2 percent. The 12-hour test was conducted twice, with weight losses of 4.9 percent and 5.8 percent. Given the published degradation theory for nylon polymers, CSB concludes that the weight loss is due partly to decomposition of the plastic and partly to side reactions.

---

**Given the published degradation theory for nylon polymers, CSB concludes that the weight loss is due partly to decomposition of the plastic and partly to side reactions.**

---

---

### A.4.5 Advanced Thermal Analysis

BP Amoco retained Kinetica, Inc., of Franklin, Ohio, to conduct thermal stability testing of the finished plastic. Kinetica used an accelerating rate calorimeter (ARC) for this purpose.

When one grade of Amodel was heated in the calorimeter, pressure in the vapor space above the sample began to increase at 350°C. The rate of increase became rapid at 380°C and peaked at a value 4.3 times the initial pressure. The reaction process was observed to be endothermic, particularly during the period of pressure increase.

Two runs were also performed on a different grade of Amodel. In both of these tests, pressure initially increased at 330°C. In one test, there was a rapid rise in pressure at 370°C; in the other, pressure increased suddenly at that temperature but less rapidly. The pressure peaked at 4.5 times the initial pressure in one test and at 4.4 in the other. The reaction process was endothermic. Figure A-11—from the company's internal investigation report—depicts temperature and pressure data from the first test.

---

**The reaction process was endothermic. . . . The ARC data fully support the conclusion that the plastic decomposes.**

---

The ARC data fully support the conclusion that the plastic decomposes. The lower onset temperature for the pressure rise observed in the tests on one grade of Amodel indicates that it is more susceptible to decomposition than the other grade.

---

<sup>6</sup> Thermogravimetry measures the change in mass of a substance on heating. Losses of mass may be due to dehydration, decomposition, desorption, vaporization, or chemical reactions that create gaseous products.

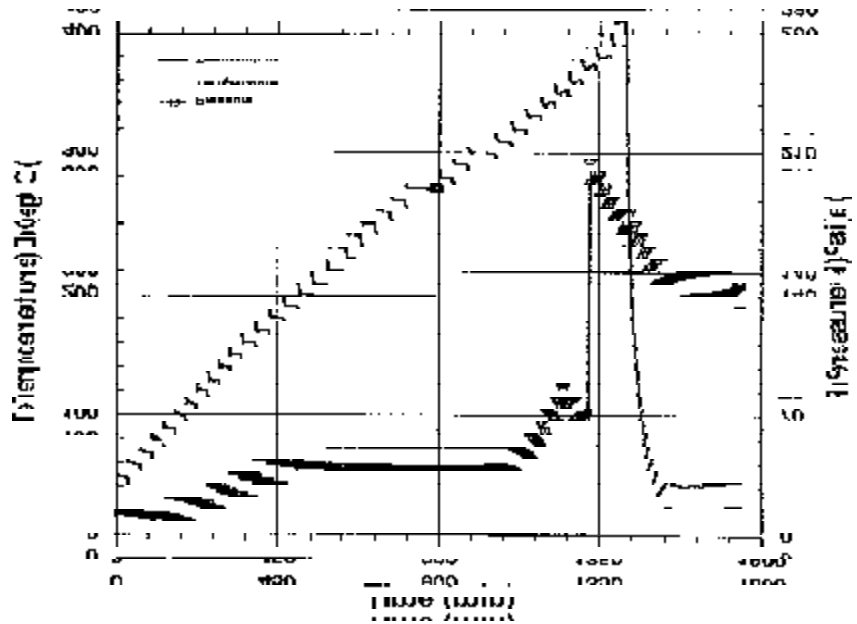

Figure A-11. ARC data for Amodel.

#### A.4.6 Analytical Chemistry

BP Amoco contracted with the Thermal Analysis Laboratory at Western Kentucky University for quantitative chemical analyses of the vapors generated from thermal degradation of Amodel. A thermogravimetric analyzer was used to heat the Amodel. The resulting vapors were captured for analysis by mass spectrometry and Fourier transform infrared spectrometry.

As reported in the company's internal investigation report, the laboratory provided the following weight conversions of the plastic for certain gases:

---

**Weight Conversions of Amodel to Certain Gaseous Products  
During Decomposition**

---

Species	Wt % generated
Carbon monoxide	0.86
Carbon dioxide	1.03
Ammonia	3.98
Water	0.52

---

The above species are all gases at moderate temperatures. From these data, CSB concludes that pressure would develop if the gases were generated in a confined environment.

The BP Amoco Performance Chemicals Laboratory in Naperville, Illinois, heated a sample of plastic extracted from the residual ring in the polymer catch tank to 340°C. The vapors that evolved were captured in a cryogenic trap for analysis by gas chromatography/mass spectrometry. A large number of organic chemicals with molecular weights below 200 were identified. Nitrile compounds were among the dominant species.

Kohan (1995) proposes that nitrile compounds are among the decomposition products from the cleavage of amide groups in certain types of nylons. Given the relatively low molecular weight of the organic compounds produced, as noted above, they could be expected to exert significant vapor pressures at the temperatures in the polymer catch tank. In light of these analyses, the nitrile compounds are expected to contribute to additional pressurization.

---

**From these data, CSB concludes that pressure would develop if the gases were generated in a confined environment.**

---

---

**Given the relatively low molecular weight of the organic compounds produced, . . . they could be expected to exert significant vapor pressures at the temperatures in the polymer catch tank.**

---

---

## A.5 Vessel Pressurization

No additional material flowed into the polymer catch tank after 3:45 pm on March 12. However, over the next several hours, reactions in the core of the vessel generated vapor that caused the viscous, molten contents to foam and expand. Eventually, the foaming material occupied the entire volume of the catch tank.

Pressure pushed the material into the vessel nozzles, including the 6-inch vent line and the emergency pressure relief inlet. As polymer reached the sides and upper surfaces of the vessel, it cooled and solidified.<sup>7</sup> The material also cooled and solidified in the vent line and emergency inlet. Once this occurred, there was no pathway for gas to escape from the vessel.

---

The material also cooled and solidified in the vent line and emergency inlet. Once this occurred, there was no pathway for gas to escape from the vessel.

---

Plugging in the vent system was extensive and continued to worsen over several hours as polymer was pushed from the polymer catch tank into the system. Eventually, the pathway through the common vent piping degraded to the extent that the emergency pressure relief system on the reactor knockout pot activated at approximately 8:10 pm on March 12.<sup>8</sup>

As heat from the polymer catch tank was gradually lost to the environment, further solidification occurred around the entire inner wall of the vessel. Although a hardened layer of polymer 3 to 5 inches thick developed, the core continued to react and decompose over several hours, generating gas. The trapped gas pressurized the vessel.

---

<sup>7</sup> Although the polymer catch tank was insulated, it was not heated with a hot oil jacket. Heat losses to the environment would cause the polymer to solidify.

<sup>8</sup> From 6:53 to 11:21 pm on March 12, water was circulated through the Amodel unit and steam was vented through the reactor knockout pot. The knockout pot and the polymer catch tank use common vent piping.

# APPENDIX B: Timeline

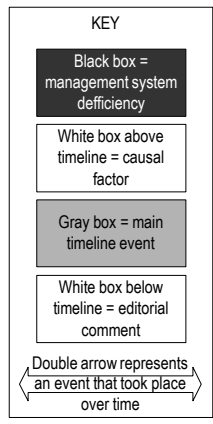
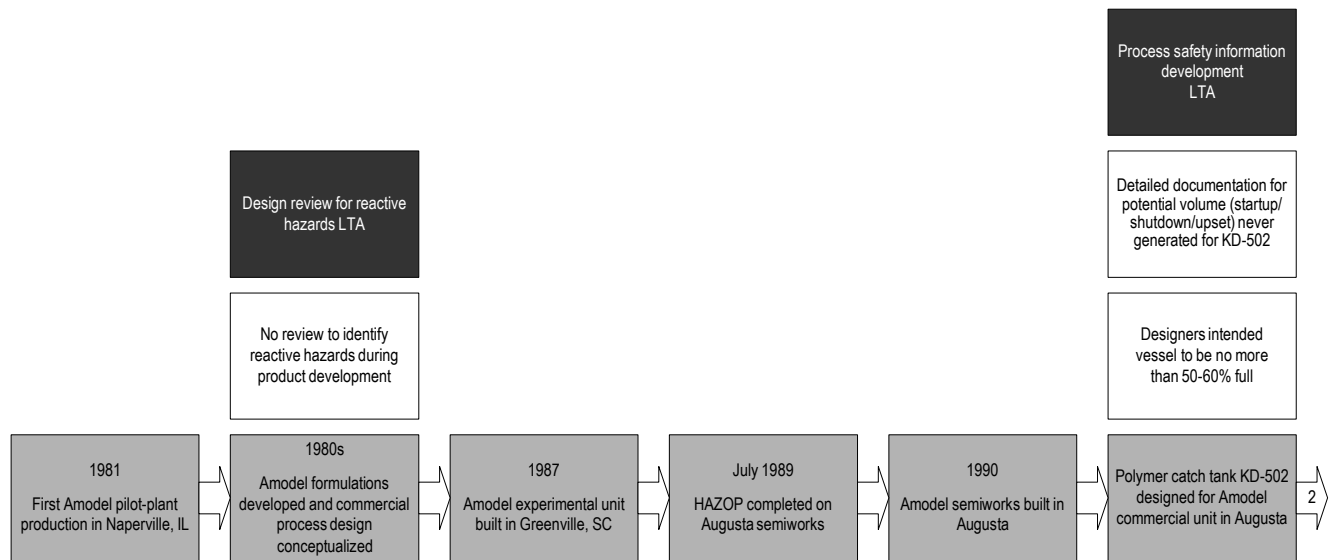

KD-501 = reactor knockout pot  
 KD-502 = polymer catch tank  
 LTA = less than adequate  
 MOC = management of change  
 PHA = process hazard analysis

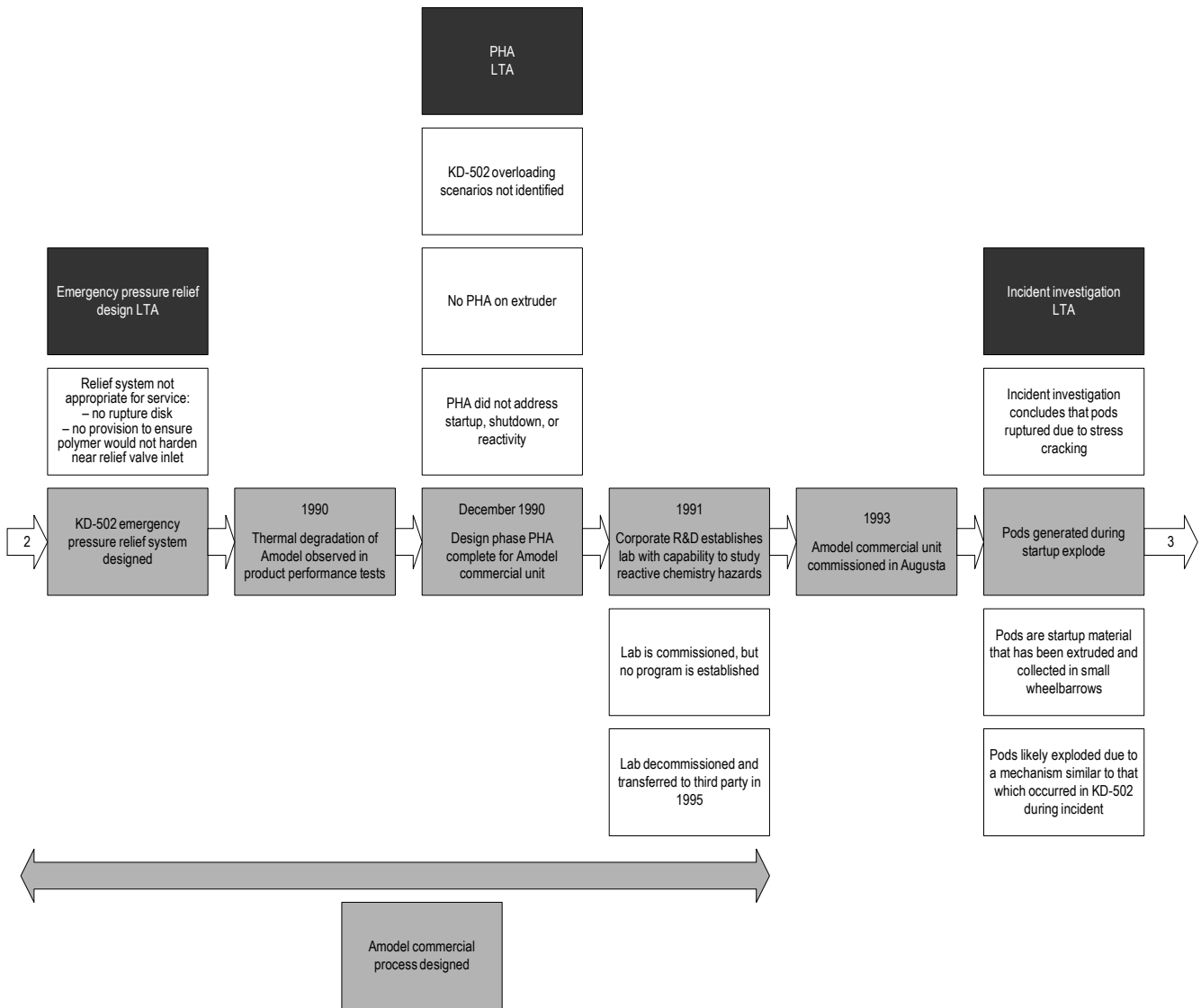

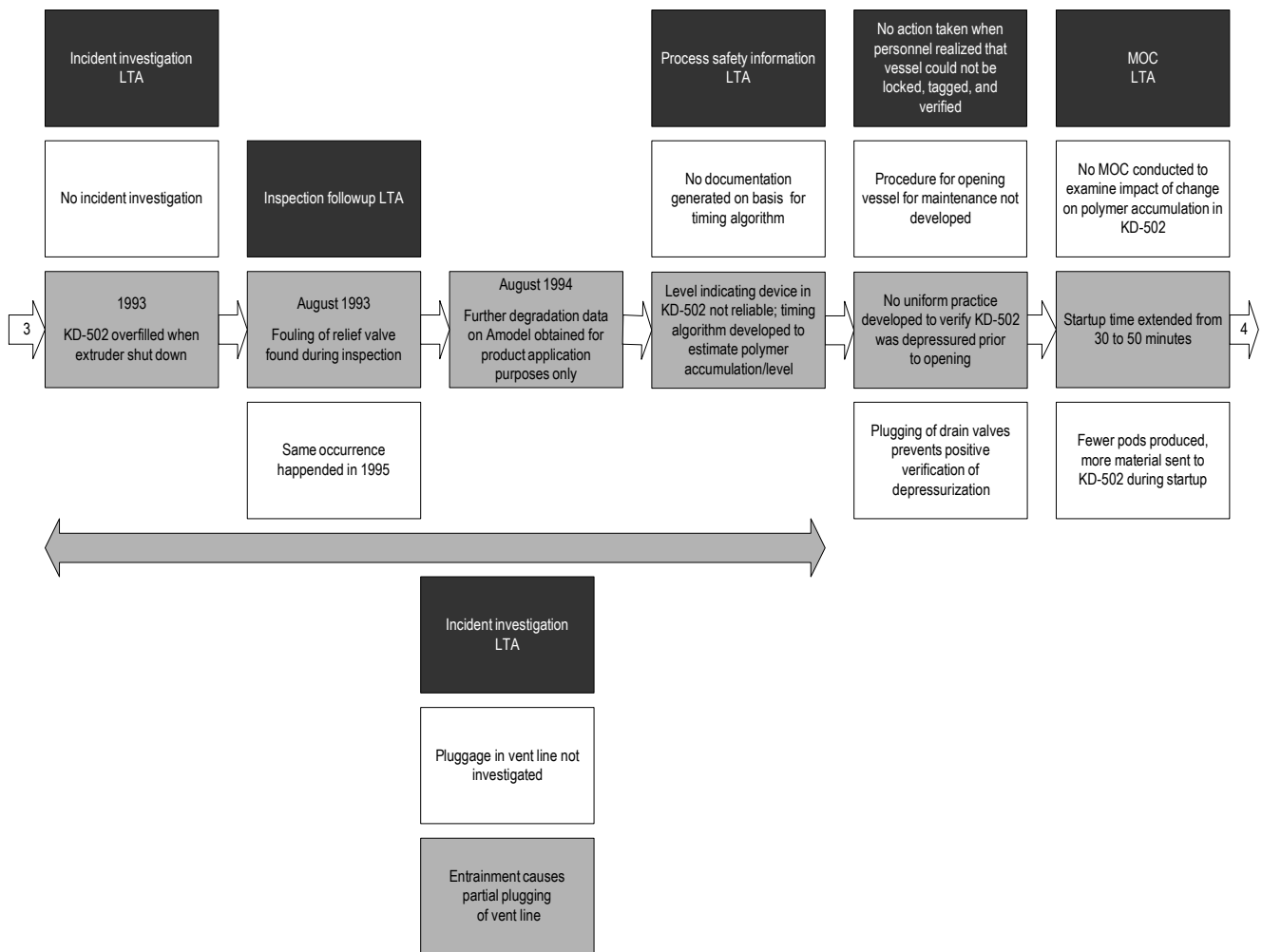

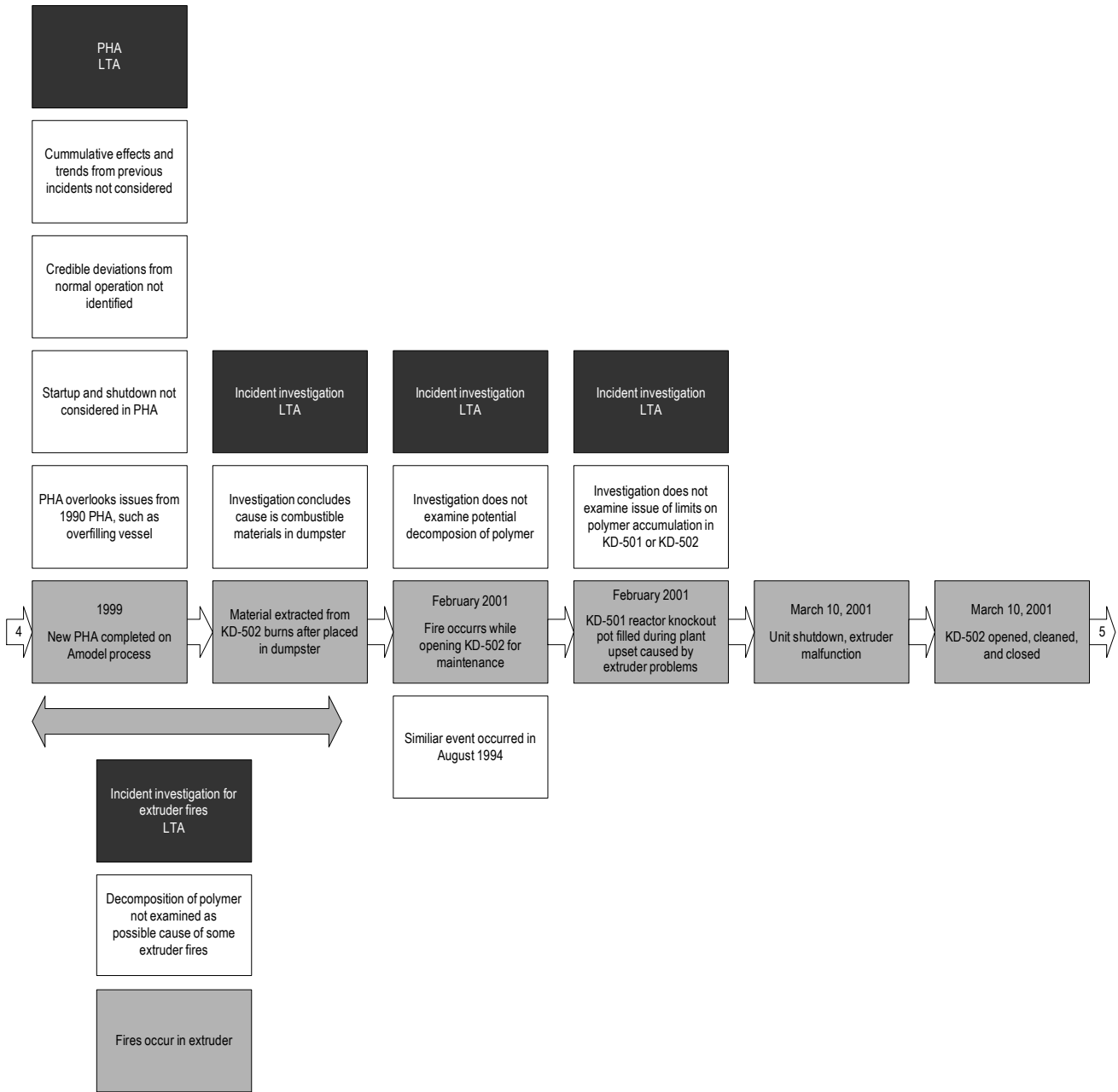



---

March 12, 2001  
2:45 am  
Extruder purged; purge fire  
occurs

March 12, 2001  
6:45 am  
Operators begin plant  
startup checklist

March 12, 2001  
9:03 am

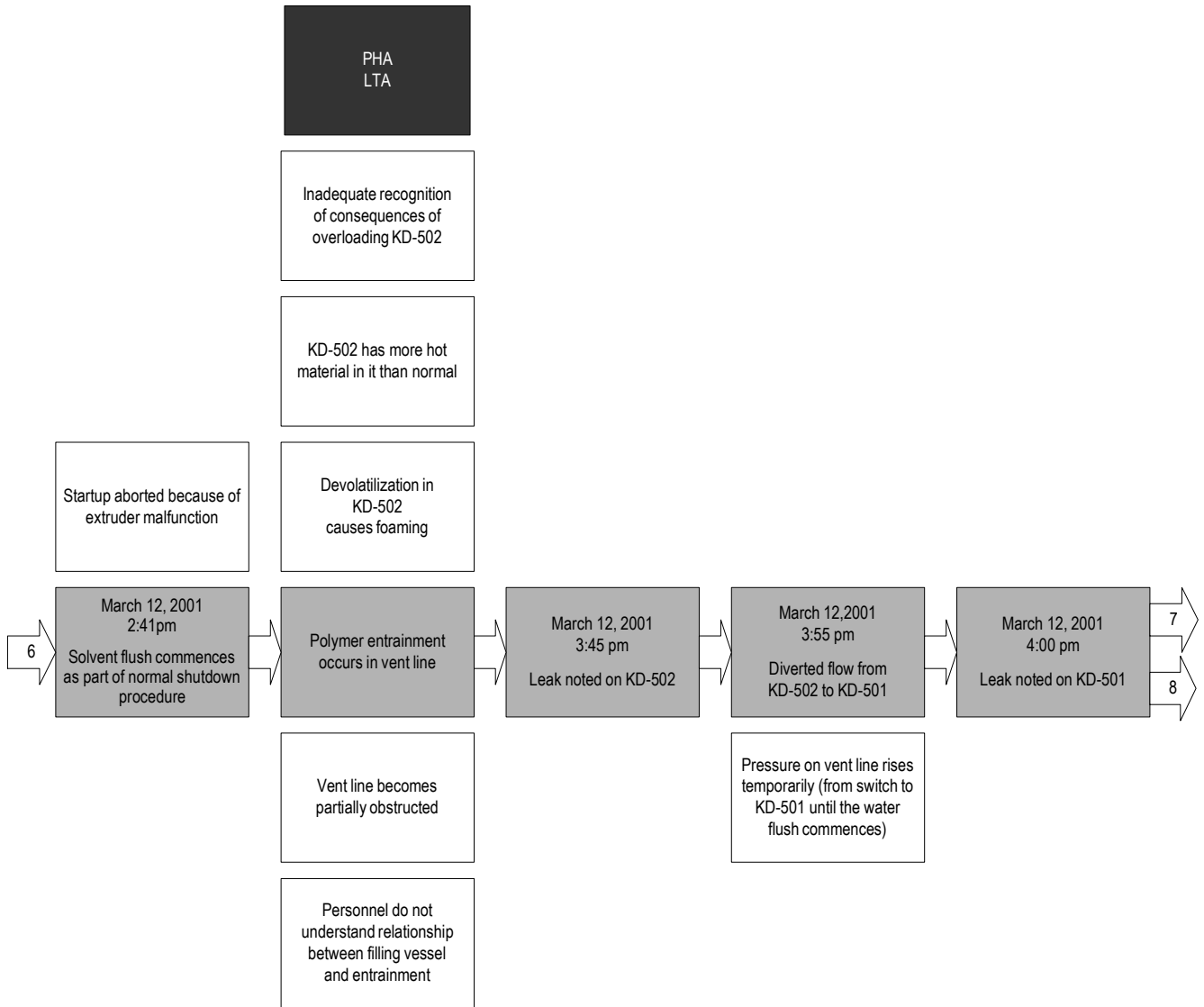

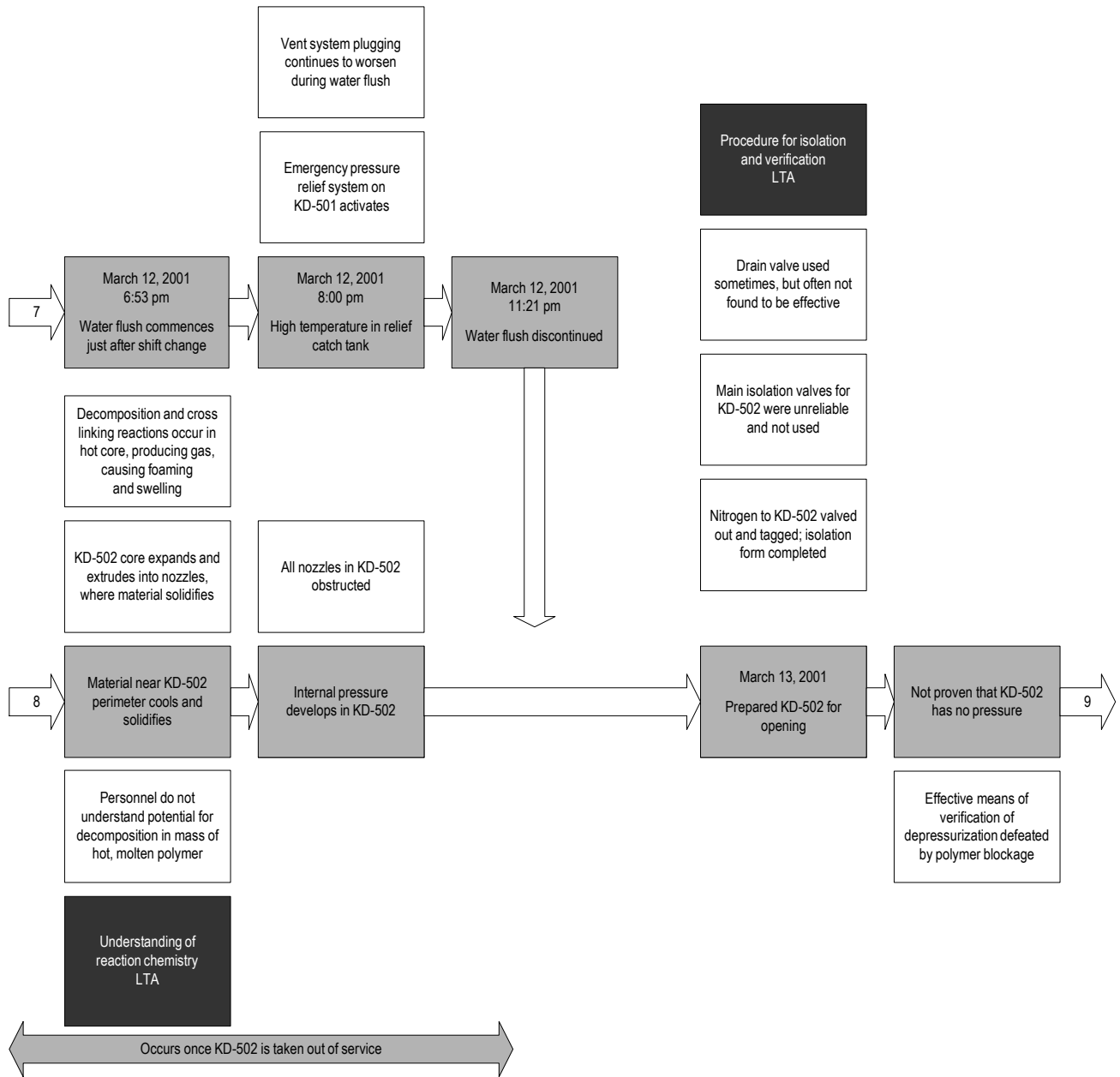

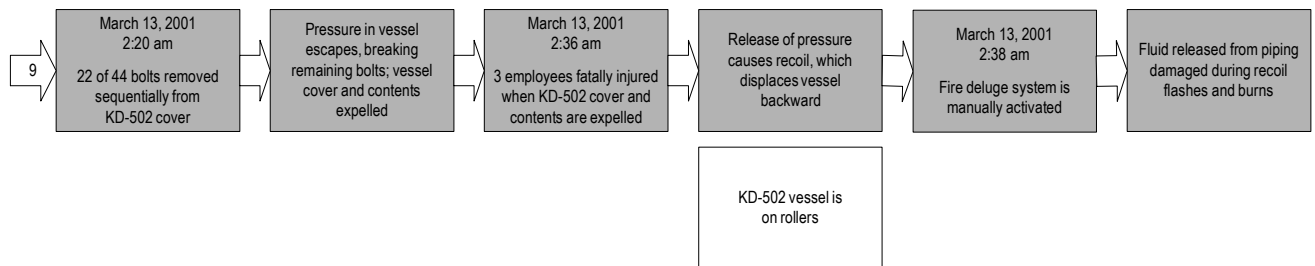

# APPENDIX C: Logic Diagram

